

F&J SPECIALTY PRODUCTS, INC.

PO Box 2888

Ocala, Florida 34478-2888

Tel: (352) 680-1177 • (352) 680-1178

Fax: (352) 680-1454

Email: fandj@fjspecialty.com **Internet:** www.fjspecialty.com

The Nucleus of Quality Air Monitoring Programs

Technical Performance Specifications for F&J Radioiodine Collection Cartridges containing TEDA Impregnated Charcoal and Silver Zeolite Media

By: FRANK M. GAVILA

NOTE:

**Enclosed data and curves for collection efficiency are typical.
Contact F&J for the current efficiency data and curves for the
RICF products utilized by your organization.**

TABLE of CONTENTS

	Page
EXECUTIVE SUMMARY	3
I. INTRODUCTION	4
II. STANDARD TEST METHODS for ADSORBENT TESTING	4
A. ASTM D3803 Test Parameters for Bulk Adsorbents	5
B. F&J Modified Test Parameters Utilized in QA Testing Program	6
III. SHORT-TERM SAMPLING SCENARIO	7
A. Efficiency vs. Flow Rate Graphs	8 – 13
IV. INTERMEDIATE-TERM SAMPLING SCENARIO	14
A. Efficiency vs. Flow Rate Graphs (Charcoals)	15 – 19
B. Efficiency vs. Flow Rate Graphs (Zeolites)	21 – 23
V. LONG-TERM SAMPLING SCENARIO	24
A. Efficiency vs. Flow Rate Graphs	25 - 29
VI. DATA ANALYSIS AND ASSESSMENT	30
APPENDIX A	32
Particle Size Selector	
APPENDIX B	34
Pressure Drop vs. Flow Rate for TEDA Impregnated Charcoals and Silver Zeolite Media	
APPENDIX C	49
Sketches of F&J “C” Series, “B” Series and “M” Series Radioiodine Collection Cartridges	
APPENDIX D	50
Equations for Methyl Iodide Collection Efficiency vs. Flow Rate	
APPENDIX E	51
F&J ISO 9001 Certificate	

Executive Summary

F&J manufactures all radioiodine collection cartridges containing TEDA impregnated carbon or silver zeolite adsorbents under an ISO 9001 certified program. Refer to Appendix E for a copy of F&J's ISO 9001 certificate.

Each F&J radioiodine collection cartridge is manufactured to a specific set of engineering specifications to ensure repeatable performance and dimensions. F&J's quality assurance program insures the dimensions of its cartridges are within the specified tolerances and fabricated to provide consistent reproducible radioiodine collection efficiency responses, which are documented by F&J performance test data.

A report outlining the results of these test data is contained in this document for the most common geometry of radioiodine collection cartridge utilized in the nuclear industry worldwide. This popular geometry has the nominal dimension of 2¼ inch (57.2mm) diameter and 1 inch (25.4mm) of height.

F&J has analyzed its radioiodine cartridges at three different sample durations identified as Short-term, Intermediate-term and Long-term Sampling Scenarios.

Equations for the Methyl Iodide retention efficiency have been determined and presented in graphical and tabular formats for the reader's convenience.

The relationship of pressure drop vs. flow rate for each of the adsorbent mesh sizes in the 2 ¼"D × 1"H cartridge geometry have also been measured and represented graphically for the reader's convenience in Appendix B.

It is extremely important to note that the data contained in this report is applicable only to F&J manufactured products and cannot be utilized with any product manufactured by another company. Additionally, these data are only applicable to cartridges having the geometries represented by the F&J "C" Series, "B" Series and "M" Series radioiodine collection cartridges. Refer to Appendix C for illustration of the dimensions of the above cartridges.

Efficiency test data of other F&J radioiodine cartridge geometries can be obtained by submitting a request to F&J by phone, fax or letter.

Thank you for using F&J radioiodine collection cartridges. We at F&J assure you that you are utilizing the best-fabricated and best-documented radioiodine collection cartridges available in today's market. F&J cartridges will comply with all existing quality assurance requirements of your organization, INPO or the USNRC.

I. INTRODUCTION

Radioiodine collection cartridges contain adsorption media that typically include activated charcoal and zeolite media impregnated with Triethylenediamine (TEDA) and silver, respectively. The important performance capabilities to be examined are the retention efficiency and pressure differential of the filter cartridge as a function of flow rate.

In this document, retention efficiency and filter efficiency are used interchangeably.

Sampling condition parameters that are of particular importance with respect to methyl iodide retention efficiency are:

- a) flow rate (velocity)
- b) relative humidity
- c) sample duration
- d) temperature
- e) pressure

Methyl iodide is the species of choice because it is the most difficult iodide species to capture that are normally found in power plant atmospheres. $I_{(g)}$ collection efficiencies are always greater than Methyl Iodide collection values.

II. STANDARD TEST METHODS FOR ADSORBENT TESTING

A. General

The standard test method(s) which are applicable for testing nuclear grade gas phase adsorbents for methyl iodide and iodine retention capabilities are contained in ASTM D3803 Method A, 1979, for pre 1990 testing and ASTM D3803, 1989 for post 1989 testing. These standard test procedures are applied to the cartridge, rather than the bulk adsorbent material and have been utilized by F&J SPECIALTY PRODUCTS, INC. as a basis to establish the radioiodine filter efficiency performance criteria for the radioiodine adsorption cartridges manufactured and sold by F&J. The test parameters for both of the above referenced test procedures are listed in Table A on page 5 of this report.

TABLE A STANDARD TEST PROCEDURES FOR RADIOIODINE BULK ADSORBENT MATERIALS

I. ASTM D3803, 1979 METHOD A TEST PARAMETERS

The standard ASTM D3803, Method A test parameters are as follows:

1)	Pressure	1 atm
2)	Temperature	30°C
3)	Pre-humidification Period	16 hours
4)	CH ₃ I concentration (I-131)	1.75mg/m ³
5)	Loading Duration	2 hours
6)	Post Sweep Period	4 hours
7)	Bed depth	2"
8)	Velocity of Gas Stream	40 feet/second
9)	Relative Humidity	95%

Other methods of testing nuclear grade gas phase adsorbents included in the 1979 version of ASTM D3803 are as follows:

<u>ASTM D3803</u>	<u>I-131 Labeled Carrier Gas Species</u>	<u>Temp.</u>	<u>Pressure</u>	<u>% RH</u>
Method B	CH ₃ I	80°C	1 atm	95
Method C	CH ₃ I	130°C	1 atm	95
Method D	I ₂	30°C	1 atm	95
Method E	I ₂	180°C	1 atm	0

II. ASTM D3803, 1989 TEST PARAMETERS

Note:

Procedure has been re-designated as D3803-91 (RE-APPROVED 1998)

The standard ASTM D3803, 1989 test parameters are as follows:

1)	Pressure	1 atm
2)	Temperature	30°C
3)	Pre-equilibration Period	16 hours
4)	Equilibration Period	120 minutes
5)	CH ₃ I concentration (I-131)	1.75 mg/m ³
6)	Loading Duration	60 minutes
7)	Post Sweep Period	60 minutes
8)	Bed Depth	2"
9)	Velocity of Gas Stream	11.6 to 12.8 m/min.
10)	Relative Humidity	95%

B. F&J Modified Test Methods Utilized under Various Simulated Sampling Scenarios in the QA Testing Program

F&J has modified the standard ASTM Test to enable it to obtain efficiency vs. flow rate for specific radioiodine cartridge geometries. The various modifications to the standard procedures that F&J utilizes for its testing program is highlighted in blue below in Table I (Pre 1990 testing) and Table Ia (Post 1989 testing).

TABLE I
ASTM D 3803, 1979, Method A Test Parameters for F&J Sampling Scenarios
 (APPLICABLE FOR PRE-1990 TESTS)

<u>PARAMETERS</u>	<u>SHORT-TERM</u>	<u>INTERMEDIATE-TERM</u>	<u>LONG-TERM</u>
Pre-humidification period (hrs.)	None	16	16
Loading duration (hrs.)	2	2	2
Post sweep duration (hrs.)	2-4	4	168
CH ₃ I Concentration (mg/m ³)	1.75	1.75	1.75
Pressure (atm)	1	1	1
Bed depth	Actual filter	Actual filter	Actual filter
Flow rate	~14 to 198 LPM	~14 to 198 LPM	~14 to 198 LPM
Temperature (°C)	30	30	30
Relative Humidity (%)	90-95	95	95

TABLE Ia
ASTM D3803, 1989 Test Parameters for Sampling Scenarios
 (APPLICABLE FOR POST-1989 TESTS)

<u>PARAMETERS</u>	<u>SHORT-TERM</u>	<u>INTERMEDIATE-TERM</u>	<u>LONG-TERM</u>
Pre-equilibration period (hrs.)	None	16	16
Equilibration period (hrs.)	None	2	2
Loading duration (hrs.)	1	1	1
Post sweep duration (hrs.)	1	1	168
CH ₃ I Concentration (mg/m ³)	1.75	1.75	1.75
Pressure (atm)	1	1	1
Bed depth	Actual filter	Actual filter	Actual filter
Flow rate	~14 to 198 LPM	~14 to 198 LPM	~14 to 198 LPM
Temperature (°C)	30	30	30
Relative Humidity (%)	90-95	95	95

III. SHORT –TERM SAMPLING SCENARIO

The term Short-term sampling scenario represents field sample collection periods not exceeding four hours. Under this scenario, pre-humidification periods and long post sweep periods are of minor importance. To reflect the short-term sampling scenario ASTM D3803 test parameters have been modified. The test parameters for short-term sampling scenarios are presented in Table I and Table Ia under Short-Term Sampling Scenario in Section II B of this report.

Modifications to the standard test parameters for the Short Term Sampling Scenario included the following:

- a) No pre-humidification period prior to the loading of the CH₃I pollutant.
- b) Utilization of actual filter geometry
- c) Variation of flow rate to develop efficiency vs. flow rate relationship

Variable flow rates were utilized to establish the filter efficiency vs. flow rate curve for the particular adsorption media contained in the radioiodine collection cartridge of interest. Table II below represents the data for the four different mesh sizes of carbon and Table III represents data for 50×80 mesh silver zeolite available for purchase from F&J SPECIALTY PRODUCTS, INC. The four different mesh sizes for carbon and the 50×80-mesh silver zeolite material are designated as follows:

- (a) TEDA-1 10×16 U.S. Sieve
- (b) TEDA-2 30×50 U.S. Sieve
- (c) TEDA-3 20×40 U.S. Sieve
- (d) TEDA-4 12×20 U.S. Sieve
- (e) AGZ58 50×80 U.S. Sieve

The filter geometries applicable to the following data are all geometries that are nominally 2 ¼” Diameter × 1” Height. These include F&J’s “C” series, “B” series and “M” series radioiodine collection cartridges.

TABLE II
F&J Charcoal Cartridge Efficiency for Methyl Iodide Collection vs. Flow Rate
SHORT-TERM SAMPLING SCENARIO

FLOW RATE (CFM)	FLOW RATE (LPM)	TEDA-1	TEDA-2	TEDA-3	TEDA-4
		% Retention	% Retention	% Retention	% Retention
1.0	28.3	97.46,99.72	99.88,99.96	99.34	
1.5	42.4		99.90	99.74	89.00
2.0	56.6	92.85,96.24	99.53,99.03	93.15	87.93
2.5	70.8		98.78	93.17	78.00
3.0	84.9		98.55,98.11	90.02	
4.0	113.2	83.97,81.47	96.36	84.16,86.92	
4.5	127.4		93.23		
5.0	141.5			81.02,79.60	
6.0	169.8	77.46		78.19	
7.0	198.1				

Short-Term Sampling Scenario data for 50 × 80 mesh silver zeolite is presented in Table III below.

TABLE III
F&J Silver Zeolite Cartridge Efficiency for Methyl Iodide Collection vs. Flow Rate
SHORT-TERM SAMPLING SCENARIO

Flow Rate (CFM)	Flow Rate (LPM)	50×80 Mesh % Retention
0.50	14.1	99.99
1.00	28.3	99.90
1.50	42.4	99.94
2.00	56.6	99.43
2.50	70.8	99.04
3.00	84.9	98.81
3.50	99.0	97.85
4.00	113.2	96.85
4.50	127.4	96.59
5.00	141.5	96.01

A best-fit curve has been drawn through the points and extrapolated to project CH₃I retention efficiencies throughout the test data range. The Short-Term scenario test data obtained from Table II for TEDA impregnated charcoals and Table III for silver impregnated zeolites was used to produce a best-fit curve throughout the data range; including variance.

The best-fit equations representing the efficiency vs. flow rate for the Short-Term Sampling Scenario are listed below in Table IV. A quadratic expression $y = a_0x^2 + a_1x + a_2$ best represents the Methyl Iodide retention efficiency as a function of flow rate.

TABLE IV
Best Fit Equations for Short-Term Sampling Scenario

Adsorbent	Equation	Graphical Representation
TEDA-1	$y = 0.0005x^2 - 0.2529x + 106.04$	Graph 1
TEDA-2	$y = -0.0006x^2 + 0.0308x + 99.689$	Graph 2
TEDA-3	$y = -0.0002x^2 - 0.1188x + 101.52$	Graph 3
TEDA-4	$y = -0.0027x^2 - 0.1065x + 100.14$	Graph 4
AGZ58	$y = -0.0002x^2 - 0.0015x + 100.17$	Graph 5

Where y = % retention efficiency and x = flow rate in LPM

CH₃J Retention Efficiency Vs. Flow Rate
ASTM D 3803 Method A
TE1, Short, C;M;B Geometry, 8x16

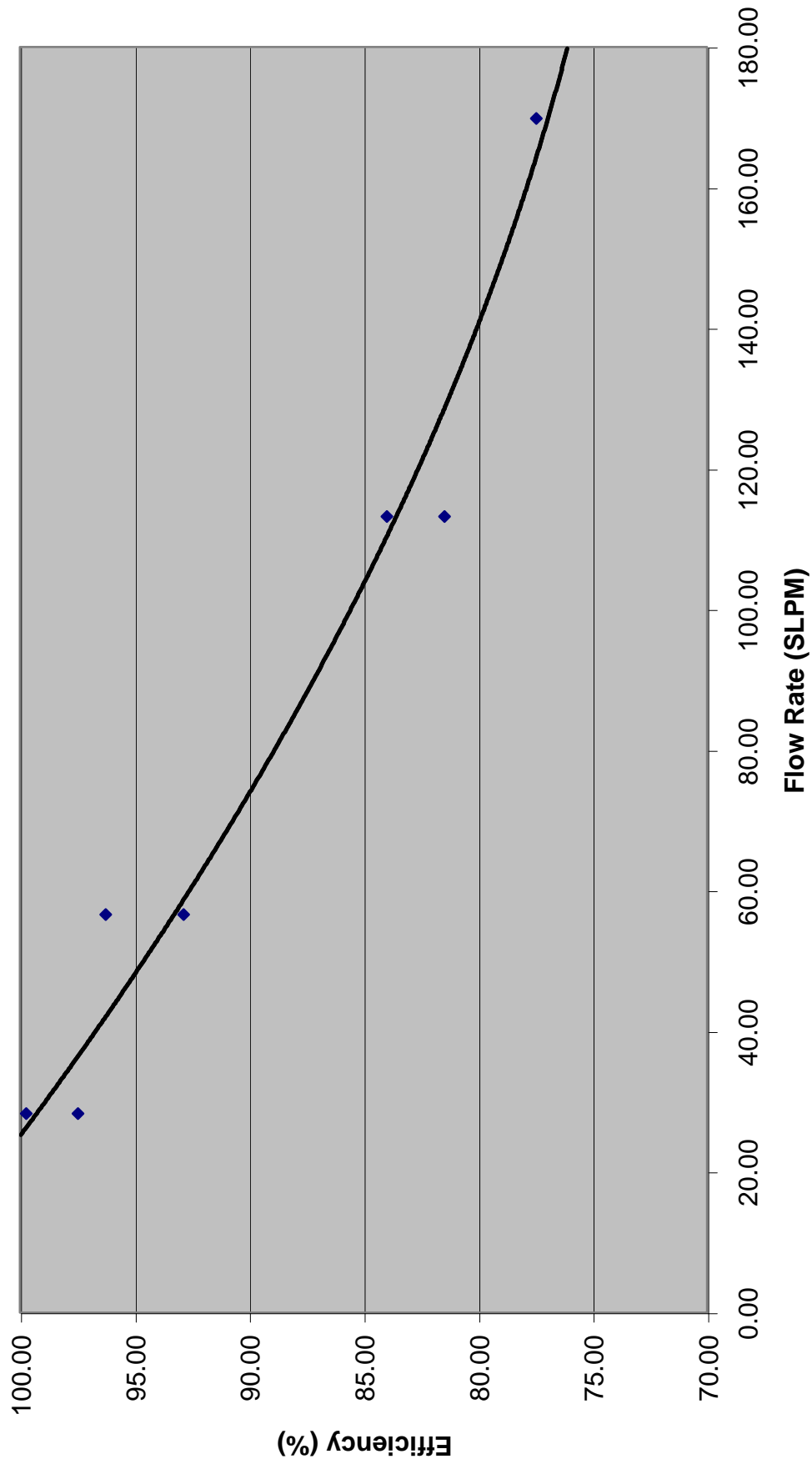

Graph 1

CH₃I Retention Efficiency Vs. Flow Rate
ASTM D 3803-1989
TE2, Short, C;M;B Geometry, 30x50, 8-20-1992

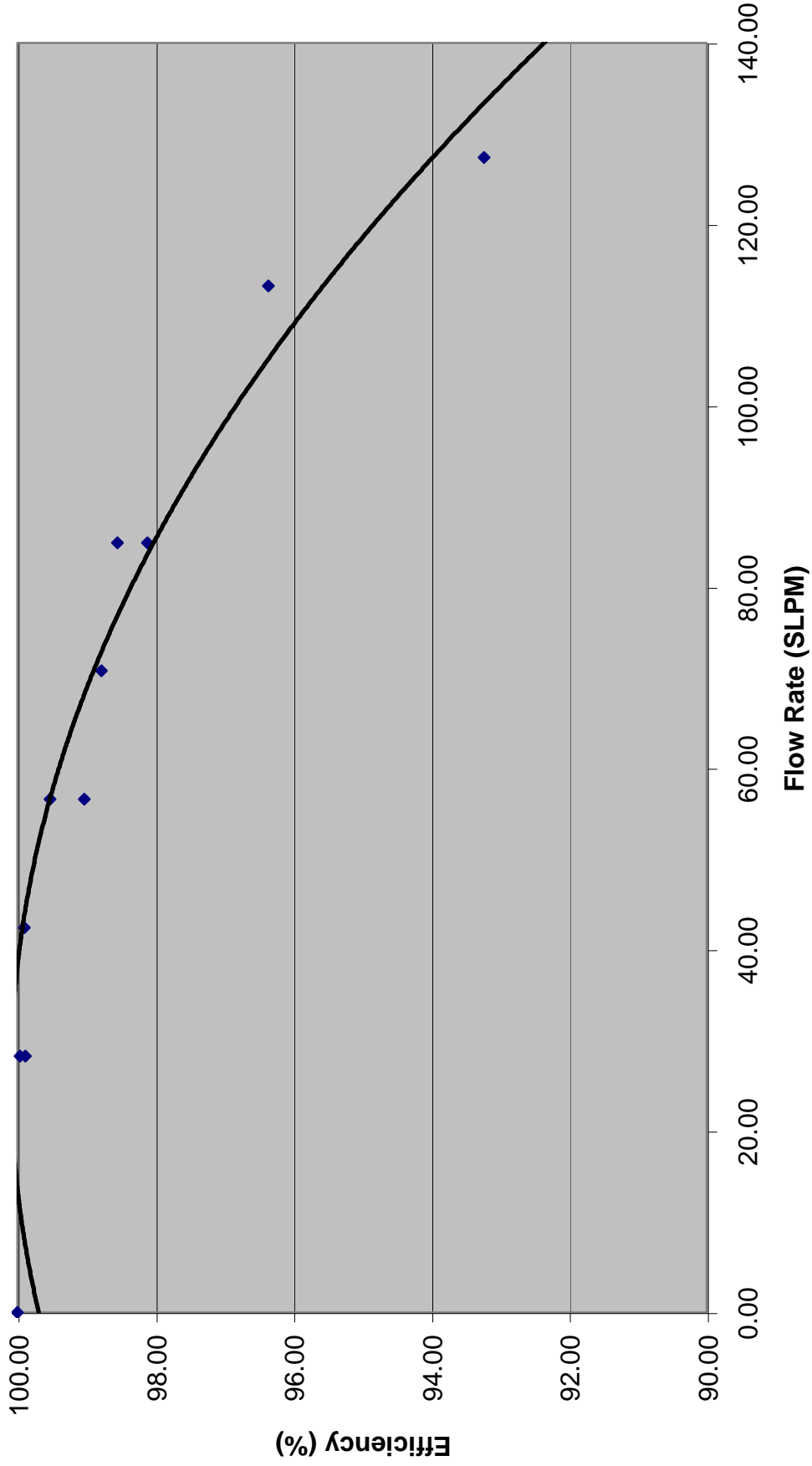

Graph 2

CH₃I Retention Efficiency Vs. Flow Rate
ASTM D 3803 Method A
TE3, Short, C;M;B Geometry, 20x40, 2-15-1988

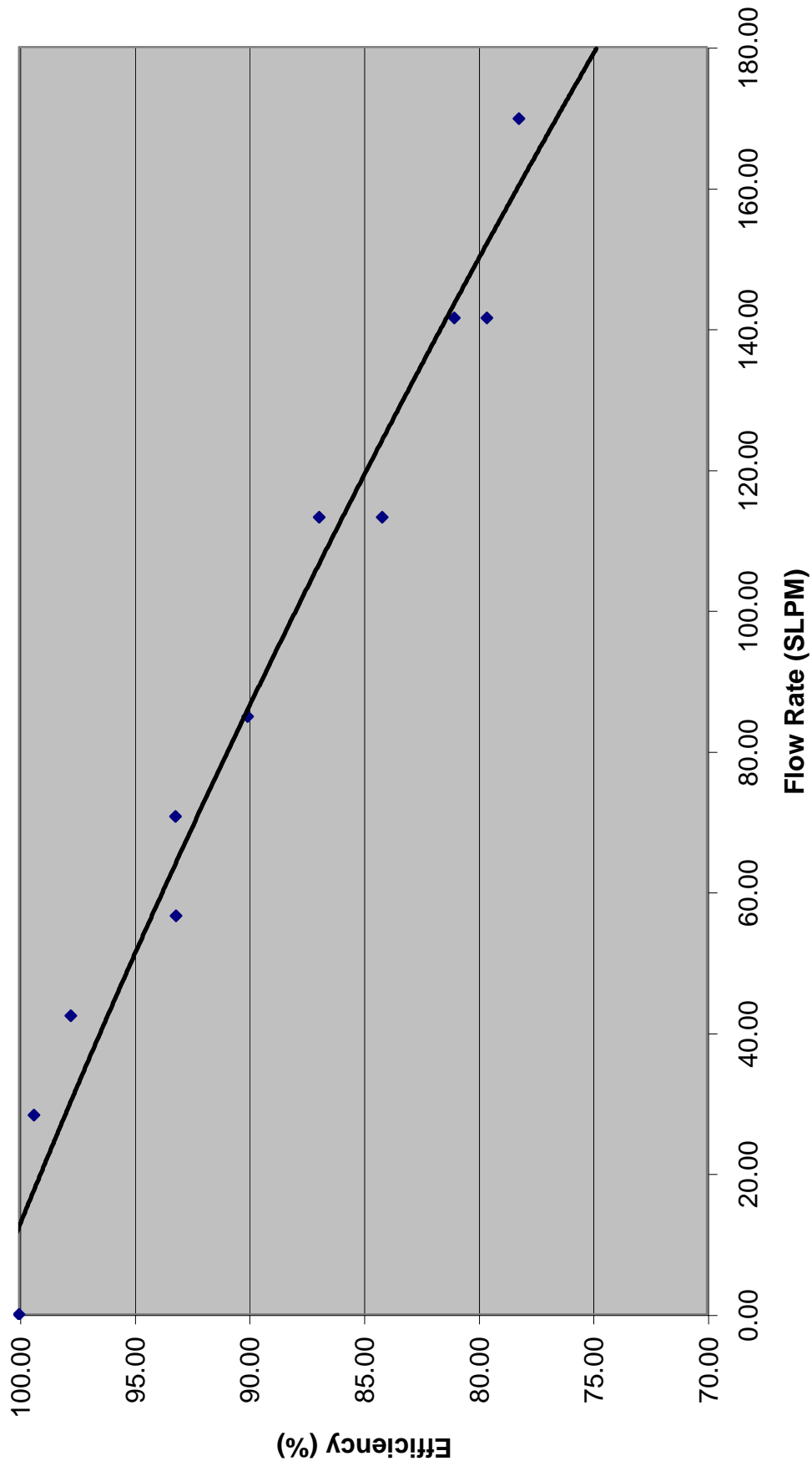

Graph 3

CH₃I Retention Efficiency Vs. Flow Rate
ASTM D 3803 Method A
TE4, Short, C;M;B Geometry, 12x20, 6-9-1987

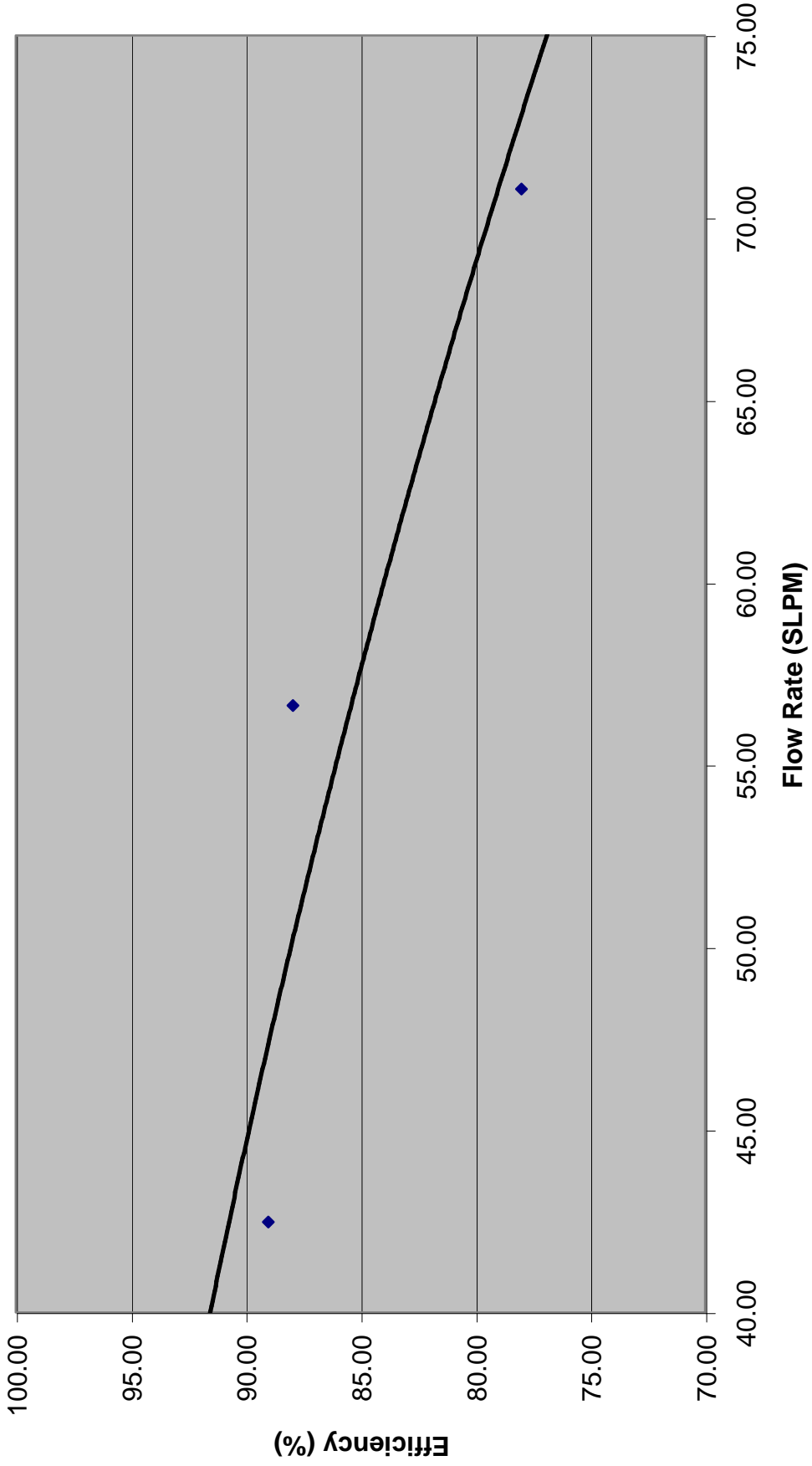

Graph 4

CH₃I Retention Efficiency Vs. Flow Rate
ASTM D 3803 Method A
AGZ58, Short, C;M;B Geometry, 50x80, November 2004

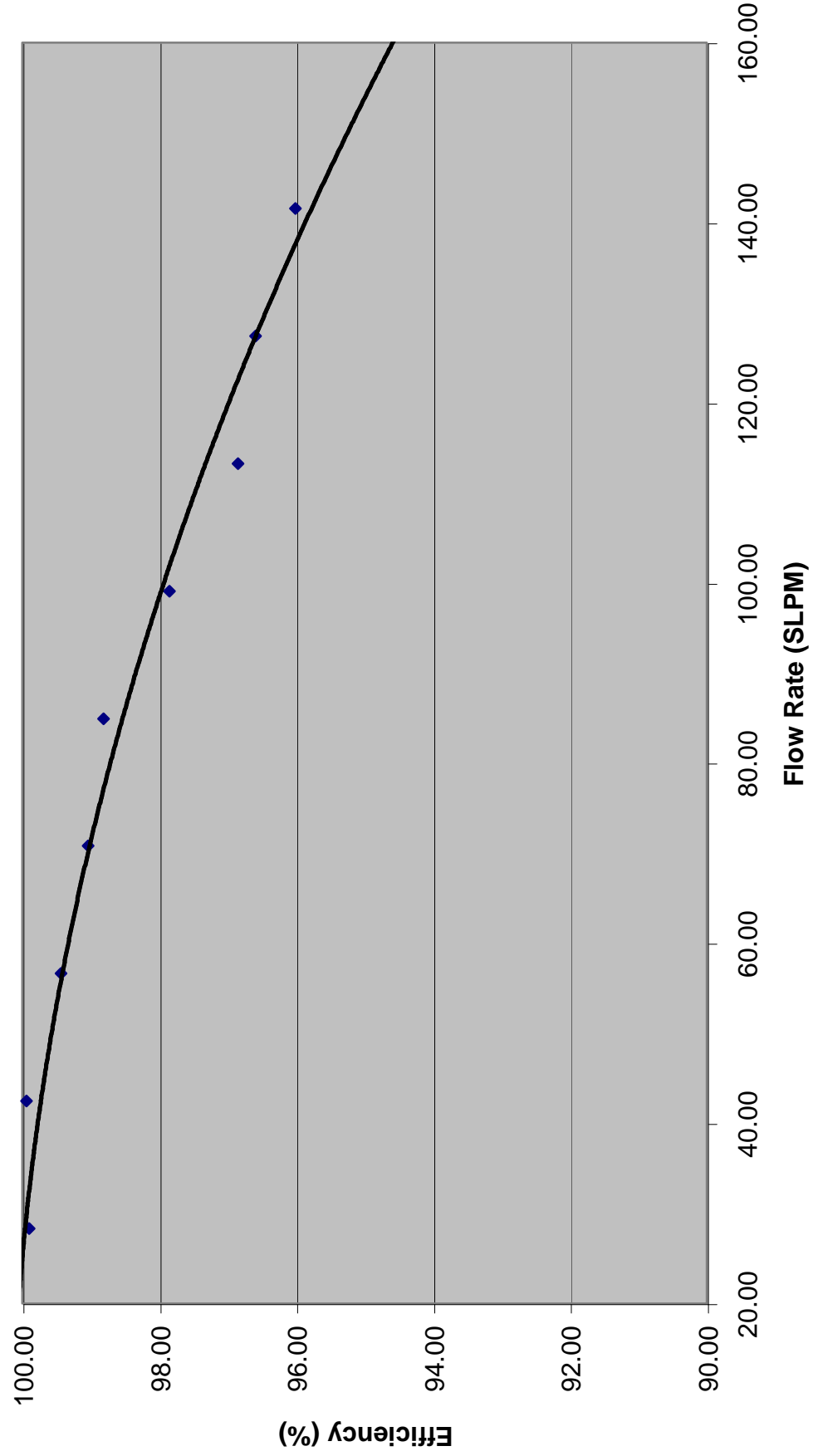

Graph 5

IV. INTERMEDIATE-TERM SAMPLING SCENARIO

The term Intermediate term sampling represents field-sampling collection periods of 24 hours. This generally is referred to in the field as daily sampling periods.

The standard test described in ASTM D3803, 1979, Method A and the ASTM D3803, 1989 provide the best simulation of actual Intermediate-Term field sampling.

Modifications to the standard test parameters for Intermediate-Term Sampling Scenario include the following:

- (a) Utilization of actual filter geometry
- (b) Variation of flow rate to develop efficiency vs. flow rate relationship.

Variable flow rates were utilized to establish the filter efficiency vs. flow rate curve for the particular adsorption media contained in the radioiodine collection cartridge of interest. Table V and Table VII on pages 15 and 20, respectively, represent the data for the four different mesh sizes of carbon and three different mesh sizes of silver zeolite, respectively. These are presently in use and available from F&J SPECIALTY PRODUCTS, INC. The adsorbent material designations are listed below:

- (a) TEDA-1 10×16 U.S. Sieve
- (b) TEDA-2 30×50 U.S. Sieve
- (c) TEDA-3 20×40 U.S. Sieve
- (d) TEDA-4 12×20 U.S. Sieve
- (e) AGZ164 16×40 U.S. Sieve
- (f) AGZ35 30×50 U.S. Sieve
- (g) AGZ58 50×80 U.S. Sieve

TABLE V
F&J Charcoal Cartridge Efficiency for Methyl Iodide Collection vs. Flow Rate
INTERMEDIATE TERM SAMPLING SCENARIO

Flow Rate (CFM)	Flow Rate (LPM)	TEDA-1 % Retention	TEDA-2 % Retention	TEDA-3 % Retention	TEDA-4 % Retention
0.50	14.1	98.27	100.00, 99.99	99.99	98.43, 98.38
0.75	21.2		100.00	100, 100, 99.98	
1.00	28.3	93.73	99.95, 98.55, 99.99	99.62, 96.70, 99.56, 97.64, 99.99	
1.06	30.0		98.60, 99.80	99.26	
1.25	35.4		99.79	99.91	
1.50	42.4		99.97, 99.80	99.77, 99.95	79.87
1.75	49.5		99.39, 98.79	97.41, 99.36	75.91
2.00	56.6	80.04	97.85, 98.93, 98.97, 99.50	96.36, 95.20, 91.45, 95.44, 96.68, 99.45	
2.15	60.8			97.22	
2.25	63.7	72.01	99.62	98.68	
2.50	70.8		98.71, 98.43	84.90, 94.61	65.05
2.75	77.8		98.20	95.51	65.98
3.00	84.9	70.38	97.76, 97.27	91.57, 87.18, 93.11	
3.18	90.0		96.64	90.79	
3.25	92.0		93.79	89.54	
3.50	99.0		98.25	97.88	
3.75	106.1		96.27	89.44	
4.00	113.2		96.32, 93.68	88.43, 87.36, 84.93	
4.25	120.3	55.91	92.78, 93.84	85.93, 96.14	
4.50	127.4		92.86, 88.94	89.00, 88.86	
4.75	134.4		93.04	85.10, 82.78	
5.00	141.5		95.72	83.40, 82.22	
5.30	150.0			80.45	
6.00	167.8		85.62	74.74, 78.07, 76.72, 79.17	
6.25	176.9			76.22	
7.00	198.1		87.08		
8.00	226.4			72.67	
10.00	283.0			69.03	

A best-fit curve has been drawn through the Intermediate-Term Scenario data points for the TEDA impregnated carbons and extrapolated to project CH₃I retention efficiencies throughout the test data range. The test data obtained from Table V were used to produce a best-fit curve throughout the data range; including variance.

The best-fit equations representing the efficiency vs. flowrate for the Intermediate-Term Sampling Scenario for TEDA impregnated charcoals are listed below in Table VI. A quadratic expression $y = a_0x^2 + a_1x + a_2$ best represents the methyl iodide retention efficiency as a function of flow rate.

TABLE VI
Best-Fit Equations for Intermediate-Term Sampling Scenario
TEDA IMPREGNATED CARBONS

Adsorbent	Equation	Graphical Representation
TEDA-1	$y = 0.0011x^2 - 0.5502x + 106.65$	Graph 6
TEDA-2	$y = -0.0003x^2 - 0.0128x + 100.49$	Graph 7
TEDA-3	$y = 0.00006x^2 - 0.1519x + 104.13$	Graph 8
TEDA-4	$y = 0.0041x^2 - 0.9045x + 110.48$	Graph 9

Where y = % retention efficiency and x = flow rate in LPM

CH₃I Retention Efficiency Vs. Flow Rate
ASTM D 3803-1998
TE1, Intermediate, C;M;B Geometry, 8x16, I-4316, Oct, 2002

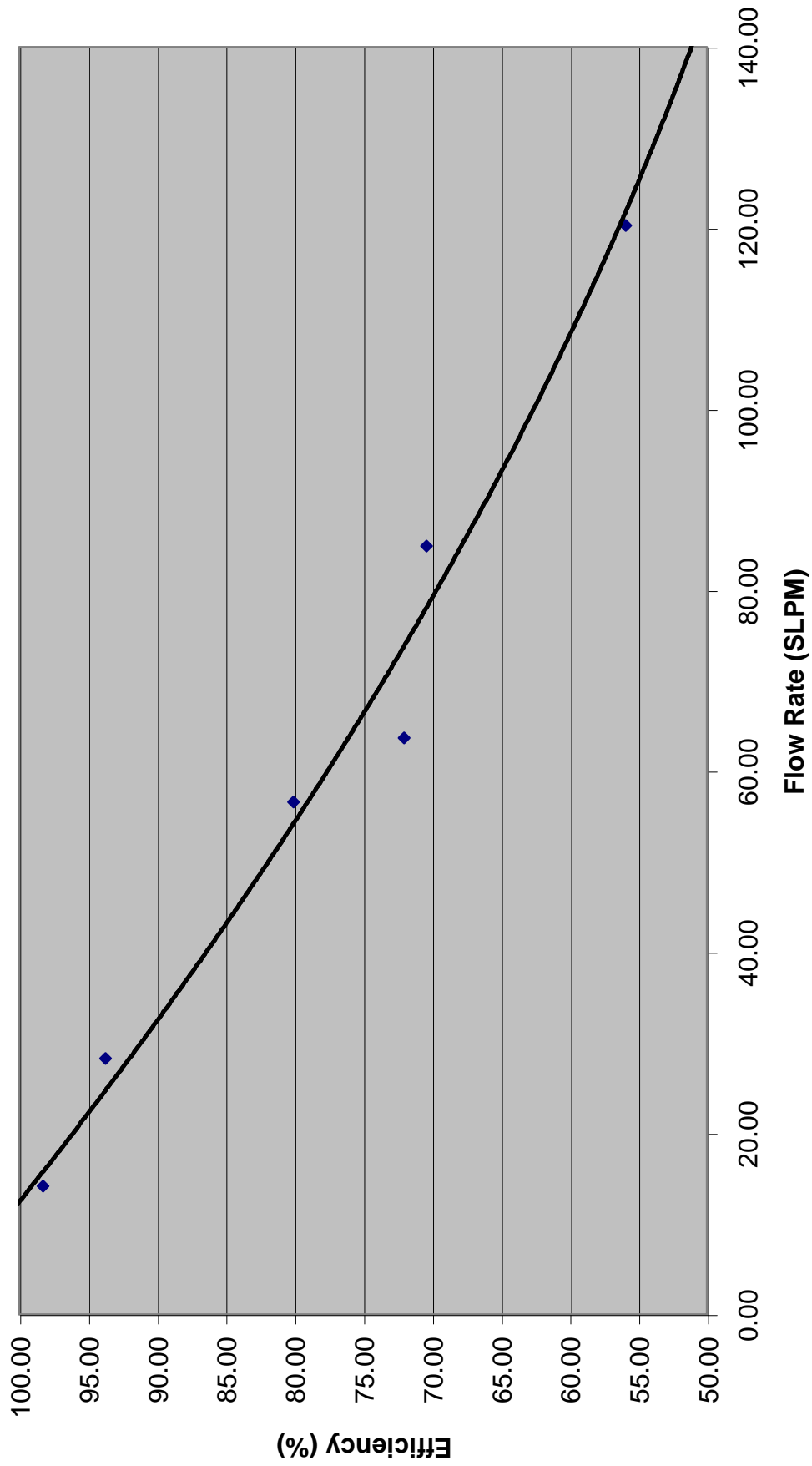

Graph 6

CH3I RETENTION EFFY. VS. FLOW RATE
ASTM 3803-1989
TE2, INT, C;M;B Geometry, 30x50, I-5181, December 2003

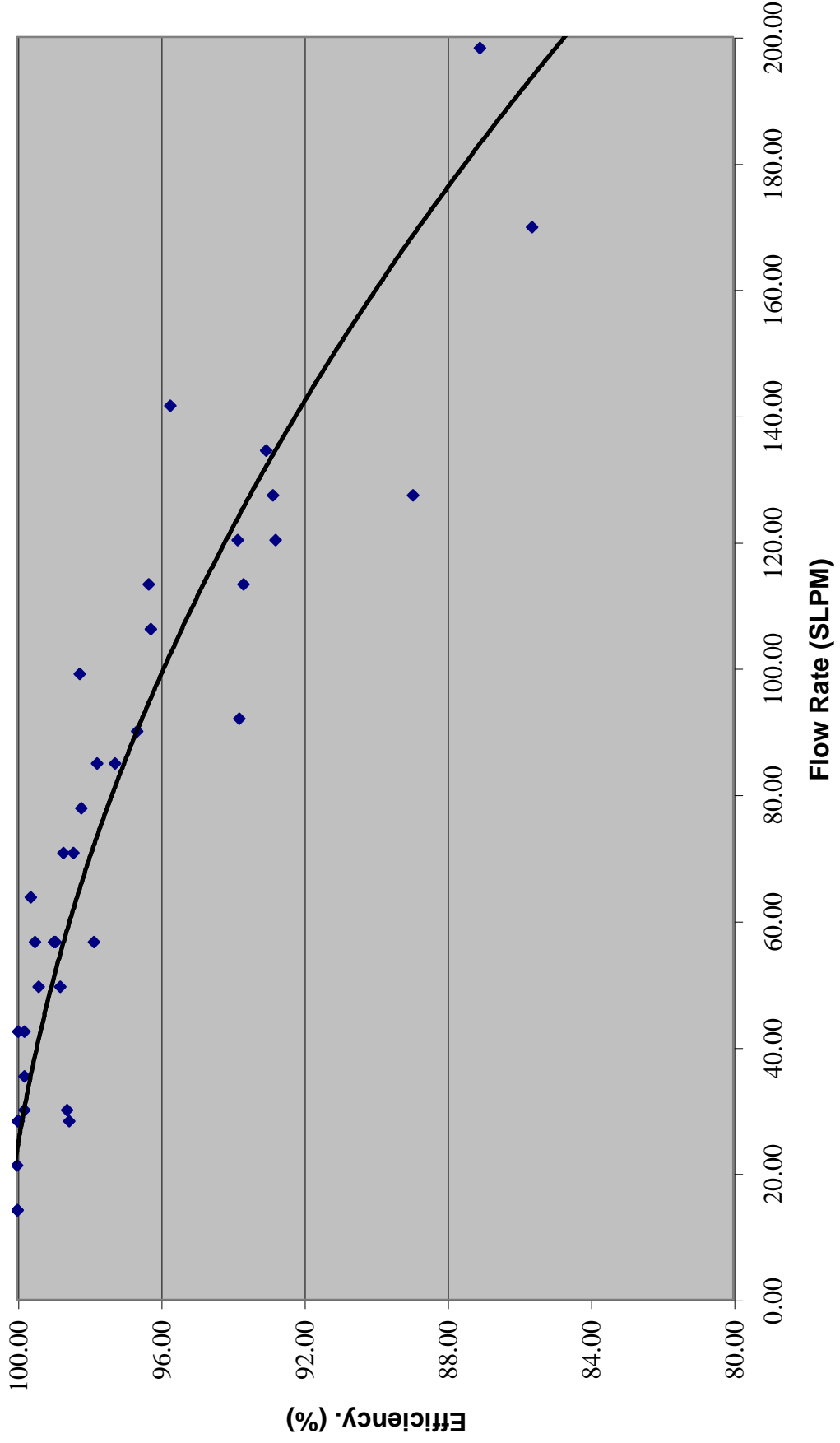

Graph 7

CH₃I Retention Efficiency Vs. Flow Rate
ASTM D 3803-1989
TE3, Intermediate, C;M;B Geometry, 20x40, July 2000

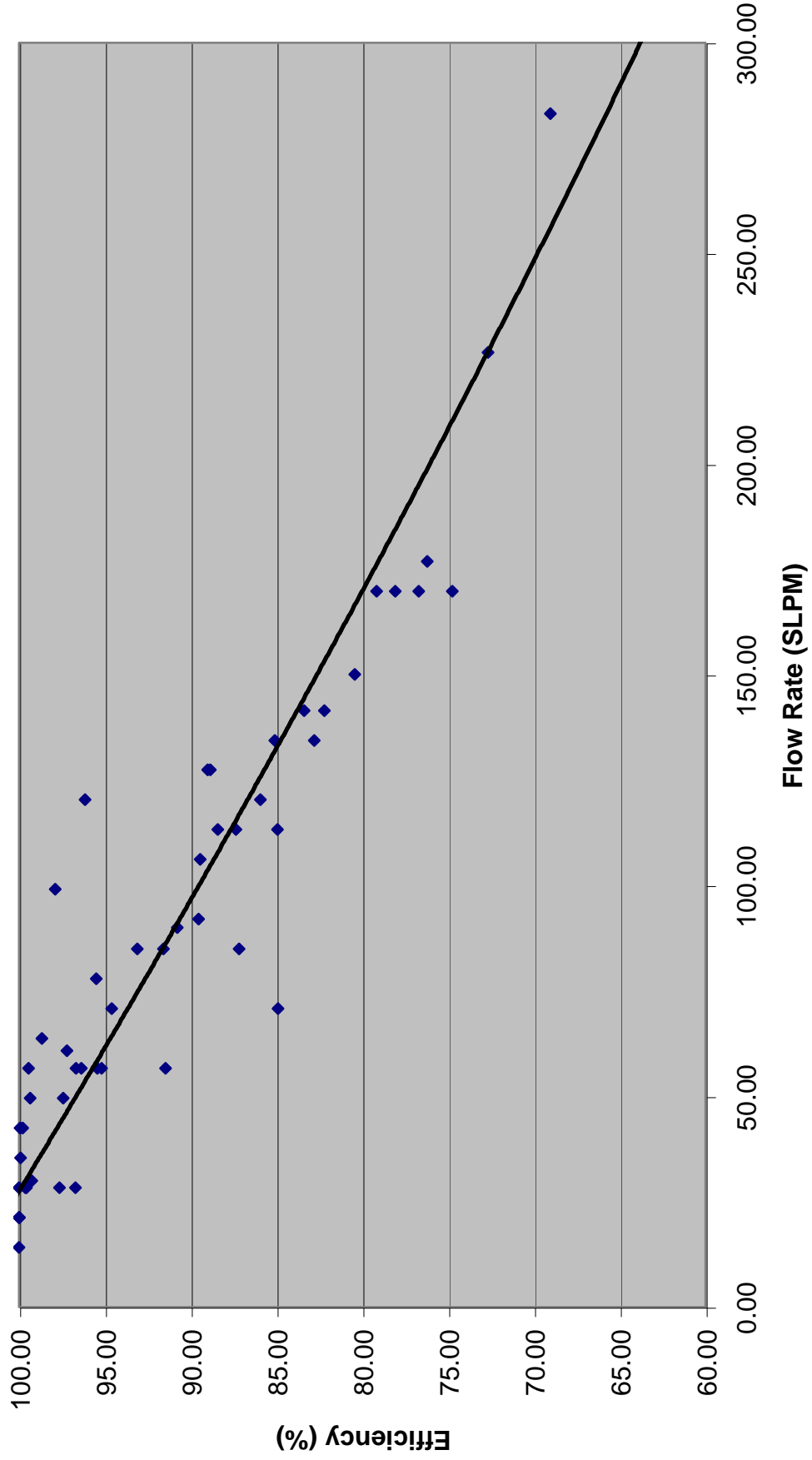

Graph 8

CH₃I Retention Efficiency Vs. Flow Rate
ASTM D 3803-1989
TE4, INT, C;M;B Geometry, 12X20, December 2003

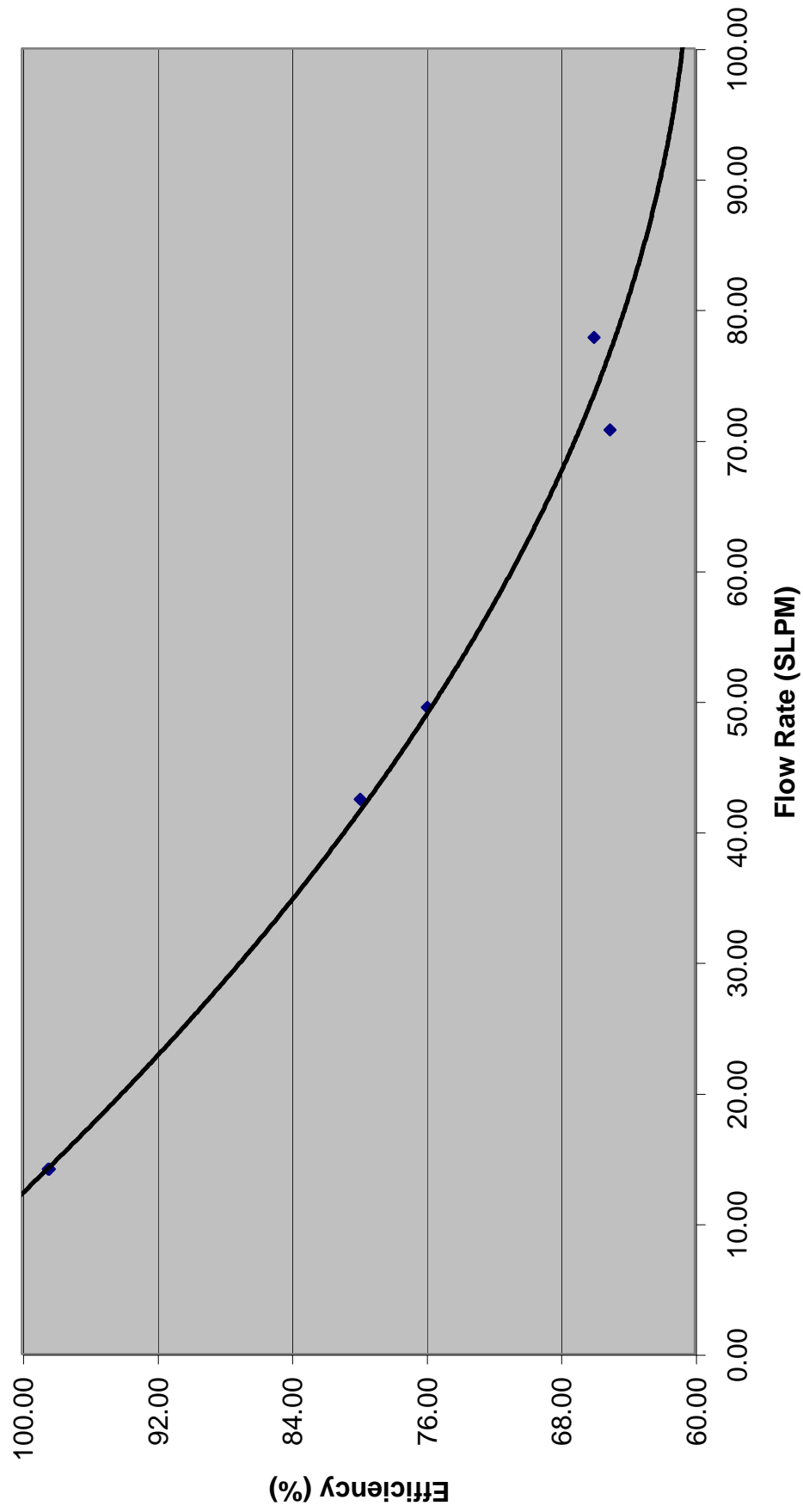

Graph 9

TABLE VII
Typical Silver Impregnated Zeolites CH₃I Retention Efficiency vs. Flow Rate
INTERMEDIATE-TERM SAMPLING SCENARIO

Flow Rate (CFM)	Flow Rate (LPM)	AGZ164 % Retention	AGZ35 % Retention	AGZ58 % Retention
0.00	0.0			100.00
0.50	14.1		99.98	99.99, 99.99, 99.99, 99.96
0.75	21.2		99.94, 99.88, 99.97	99.99, 99.99
0.90	25.5		99.86	
1.00	28.3	98.36, 98.12	93.79, 99.79, 99.21	99.86, 99.99, 99.99, 98.89
1.25	35.4	97.86	99.80, 98.89, 99.05	100.00, 99.97
1.50	42.4	94.53	95.58, 98.90, 95.79, 97.82	99.47, 99.66, 99.90
1.65	46.7		98.65	
1.75	49.5	94.97	96.49, 98.72	99.93
2.00	56.6	92.64	95.04, 98.45, 96.82, 97.36, 97.51	98.92, 97.87
2.15	60.8		97.25	
2.25	63.7	91.58	93.82, 95.88	99.38
2.50	70.8	87.02	92.03, 93.94, 89.53, 95.11	96.56
2.75	77.8	84.66	94.09, 90.57	99.98
3.00	84.9	87.80	91.83, 88.38, 94.41, 95.28	98.81
3.25	92.0		94.63, 91.14, 90.90	
3.50	99.0	78.39	87.91, 91.55, 86.90, 89.79	97.30
3.75	106.1		89.77	99.90
4.00	113.2	80.74, 81.98	85.90, 88.11, 91.36	96.54
4.25	120.3		86.42	
4.50	127.4		85.41	96.08, 97.31
4.75	134.5			99.69
5.00	141.5		84.85, 88.44	94.94
6.00	167.8			94.30
7.00	198.1			92.64
10.0	283.0			90.26

A best-fit curve has been drawn through the Intermediate-Term Scenario data points and extrapolated to project CH₃I retention efficiencies throughout the test data range. The test data obtained from Table VII was inputted into the computer program that evaluates the data to determine the best-fit equation among five different functions. The best fit was illustrated by the equation, which had the smallest standard deviation for the set of actual data points compared to the ideal dependent variables calculated by use of the best-fit equation.

The best-fit equations representing the efficiency vs. flowrate for the Intermediate-Term Sampling Scenario for silver impregnated zeolites are listed below in Table VIII. A quadratic expression $y = a_0^2 + a_1x + a_2$ best represents the methyl iodide retention efficiency as a function of flow rate.

TABLE VIII
Best Fit Equations for Intermediate-Term Sampling Scenario
SILVER IMPREGNATED ZEOLITES

Adsorbent	Equation	Graphical Representation
AGZ164	$y = 0.0007x^2 - 0.3199x + 107.53$	Graph 10
AGZ35	$y = 0.00004x^2 - 0.1357x + 103.36$	Graph 11
AGZ58	$y = -0.00007x^2 - 0.0181x + 100.36$	Graph 12

Where y = % retention efficiency and x = flow rate in LPM

CH3I Retention Efficiency Vs. Flow Rate
ASTM D 3803-1989
AGZ, INT, C;M;B Geometry, 16x40, June 2004

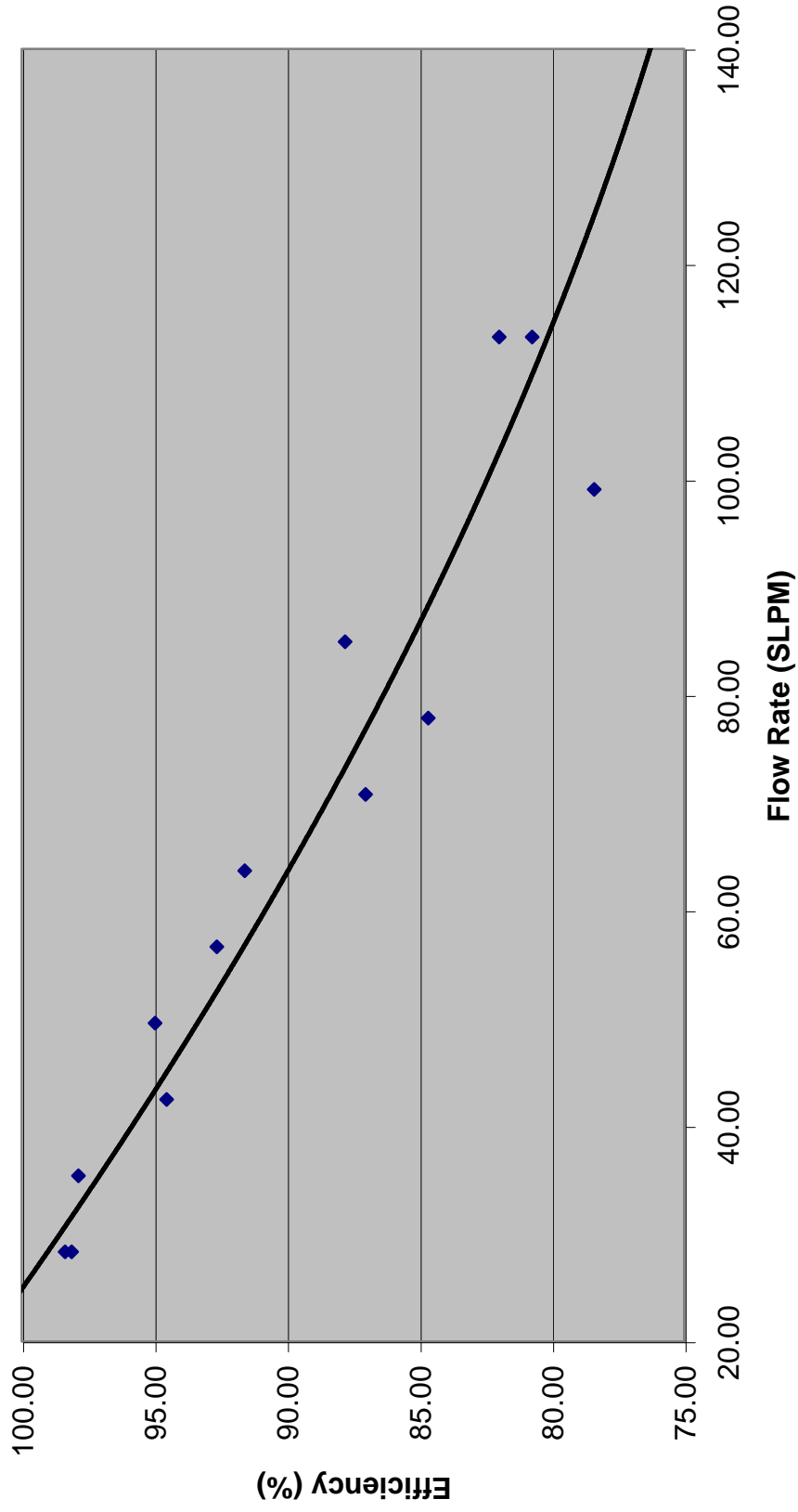

Graph 10

CH3I RETENTION EFFY. VS. FLOW RATE
ASTM 3803-1989
AGZ35, INT, C;M;B Geometry, 30x50, 0405141-2, August 2004

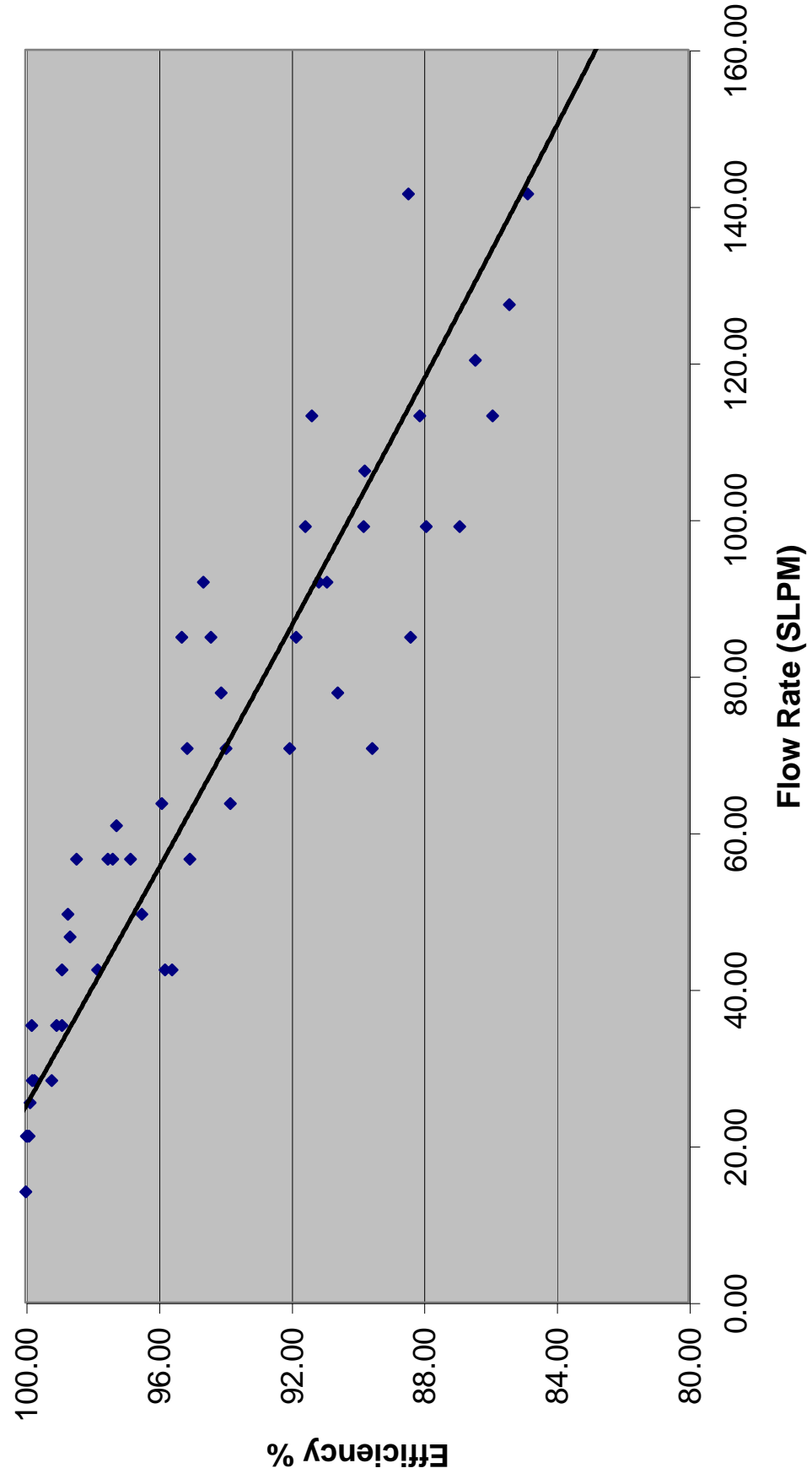

Graph 11

CH3I RETENTION EFFY. VS. FLOW RATE
ASTM 3803-1989
AGZ58, INT, C;M;B Geometry, 50x80, 0103071-1, June 2001

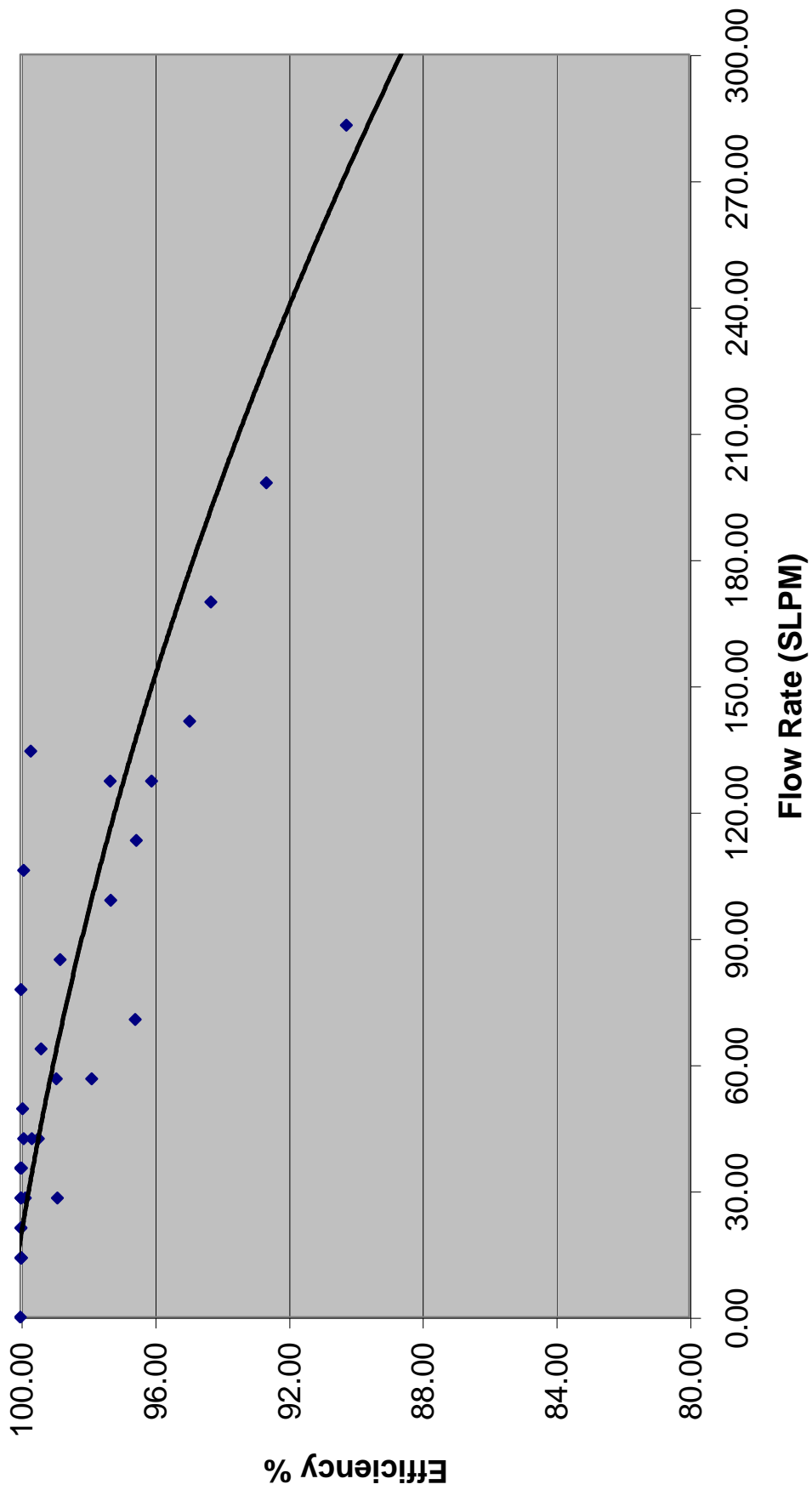

V. LONG-TERM SAMPLING SCENARIO

The term Long-Term Sampling Scenario represents field sampling durations of 7 days. This generally involves permanently installed sampling station. To simulate Long-Term Sampling Scenarios, ASTM D3803, Method A test conditions have been modified as shown in Table 1 and Table 1a in section B of this report.

Modifications include:

- a) An elution period of 168 hours
- b) Utilization of the actual filter geometry
- c) Variation of flow rate to develop efficiency vs. flow rate relationship

As in the Short-Term and Intermediate-Term sampling scenarios, actual filters identical to those available to customers were utilized in the testing. Table IX below represents the data for four TEDA impregnated charcoal mesh sizes utilized in the long-term tests. Variable flow rates were utilized to establish the filter efficiency for CH₃I vs. flow rate curve for the particular adsorption media contained in the cartridge. All cartridge dimensions were nominally 2 ¼" Diameter × 1" Height. The filter geometries applicable to the following data include the F&J "C" series, "B" series and "M" series radioiodine collection cartridges. Data for silver zeolite was not obtained under long-term sampling conditions because silver zeolite usage is geared to emergency type sampling, which is short or intermediate term in nature.

TABLE IX
F&J Charcoal Cartridge Efficiency for Methyl Iodide Collection vs. Flow Rate
LONG-TERM SAMPLING SCENARIO

Flow Rate		TEDA-1	TEDA-2	TEDA-3	TEDA-4
(CFM)	(LPM)	% Retention	% Retention	% Retention	% Retention
0.00	0.0		100.00	100.00	
0.50	14.1				
1.00	28.3	85.26		99.86	
1.06	30.0		98.76		
1.10	31.1			99.19	
1.50	42.4				88.40
2.00	56.6	71.78		97.11	83.15
2.12	60.0		99.19, 99.22		
2.50	70.8				77.29
3.00	84.9	62.89		92.42	
3.18	90.0		96.50		
3.20	90.6			89.52	
4.00	113.2				
4.20	118.9				
5.00	141.5				
5.30	150.0		95.89, 92.46	80.15	

A best-fit curve has been drawn through the points and extrapolated to project CH₃I retention efficiencies vs. flow rate throughout the test data range. Utilization of the best fit equation computer program to evaluate the data resulted in a determination that the data is best represented by a quadratic equation of the form $y=a_0x^2+a_1x+a_2$. The best-fit equations for TEDA impregnated charcoals are listed in Table X presented below.

Graphs of the efficiency vs. flowrate graphs for each of the different TEDA impregnated charcoal media is presented on pages 26 – 29.

TABLE X
Best Fit Equations for Long-Term Sampling Scenario
TEDA IMPREGNATED CHARCOALS

Adsorbent	Equation	Graphical Representation
TEDA-1	$y = 0.0029x^2 - 0.7192x + 103.33$	Graph 13
TEDA-2	$y = -0.0002x^2 - 0.0123x + 99.923$	Graph 14
TEDA-3	$y = -0.0006x^2 - 0.0492x + 100.91$	Graph 15
TEDA-4	$y = -0.0015x^2 - 0.2211x + 100.49$	Graph 16

Where y = % retention efficiency and x = flow rate in LPM

CH₃I Retention Efficiency Vs. Flow Rate
ASTM D 3803 Method A
TE1, Long, C;M;B Geometry, 8x16

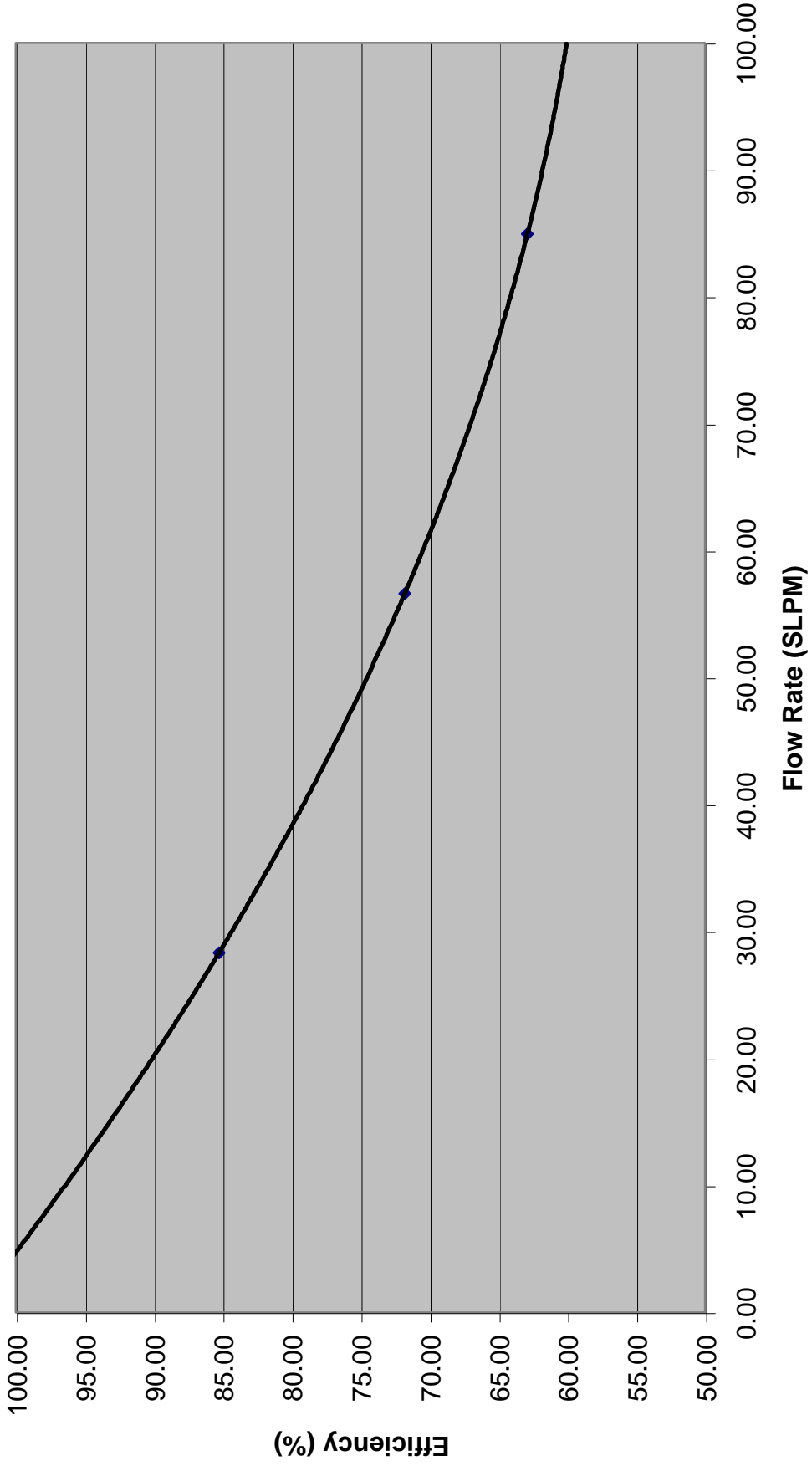

Graph 13

CH₃I Retention Efficiency Vs. Flow Rate
ASTM D 3803 Method A
TE2, Long, C;M;B Geometry, 30x50, 6-21-1984

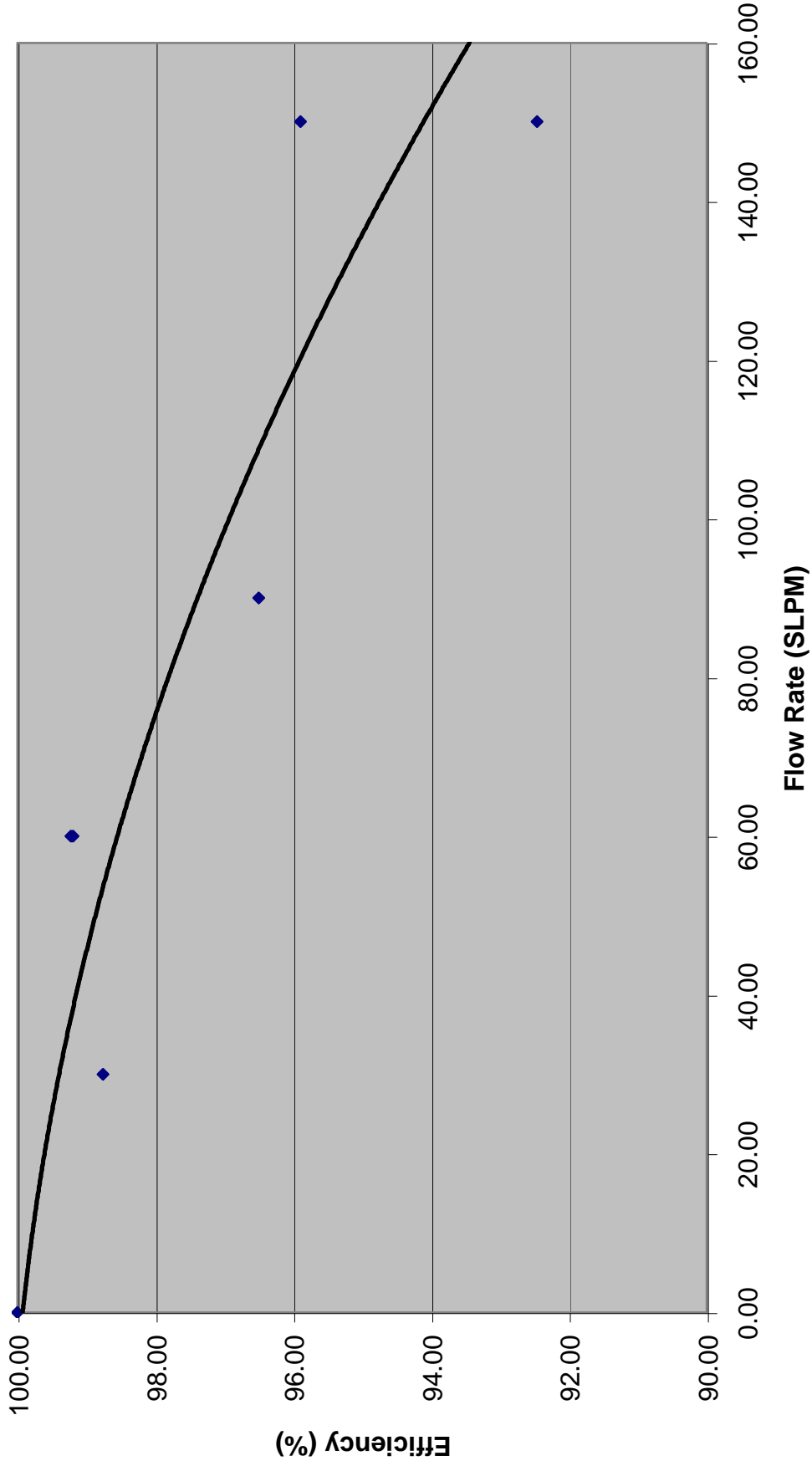

Graph 14

CH₃I Retention Efficiency Vs. Flow Rate
ASTM D 3803 Method A
TE3, Long, C;M;B Geometry, 20x40, 4-29-1985

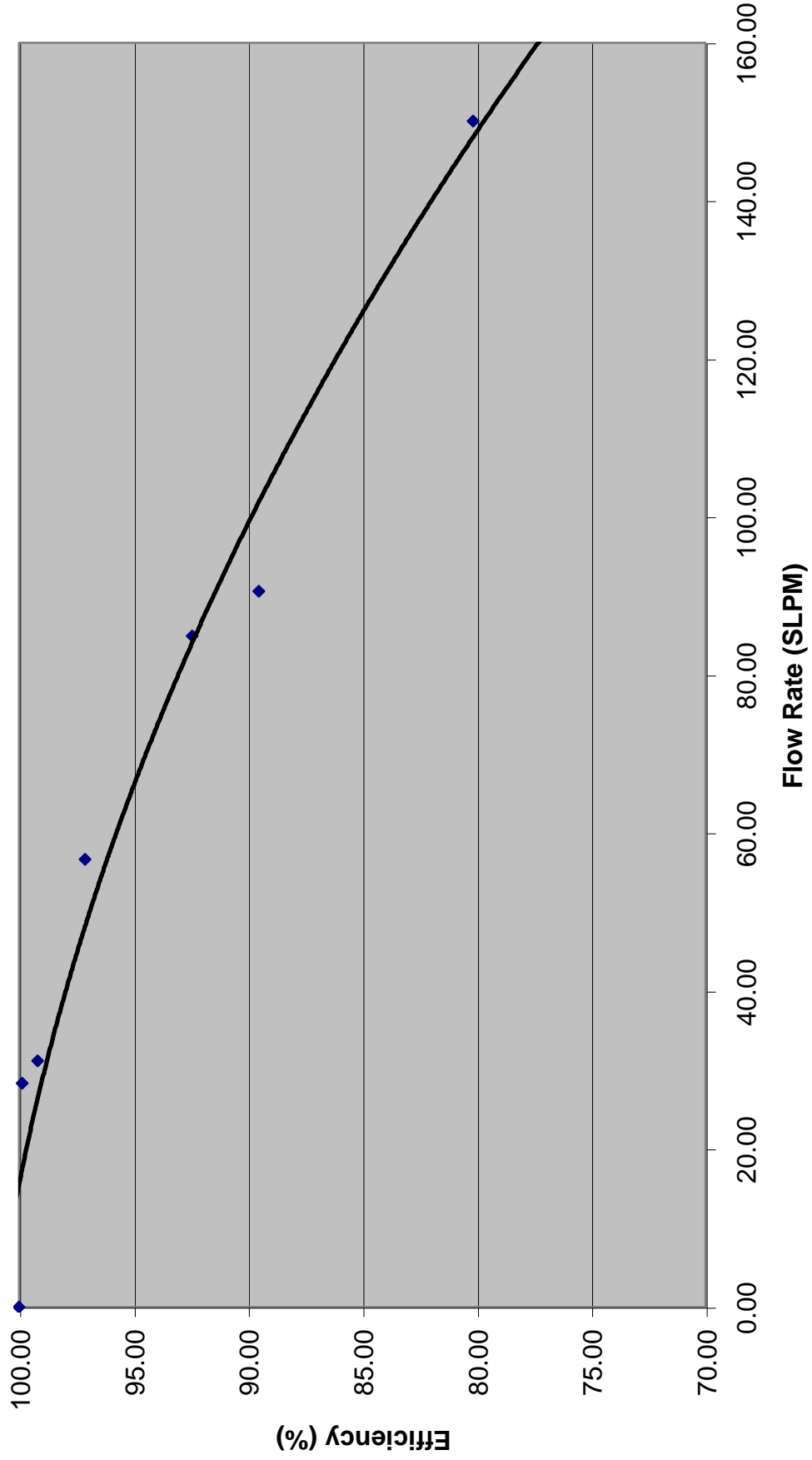

Graph 15

CH₃I Retention Efficiency Vs. Flow Rate
ASTM D 3803 Method A
TE4, Long, C;M;B Geometry, 12x20, 6-26-1987

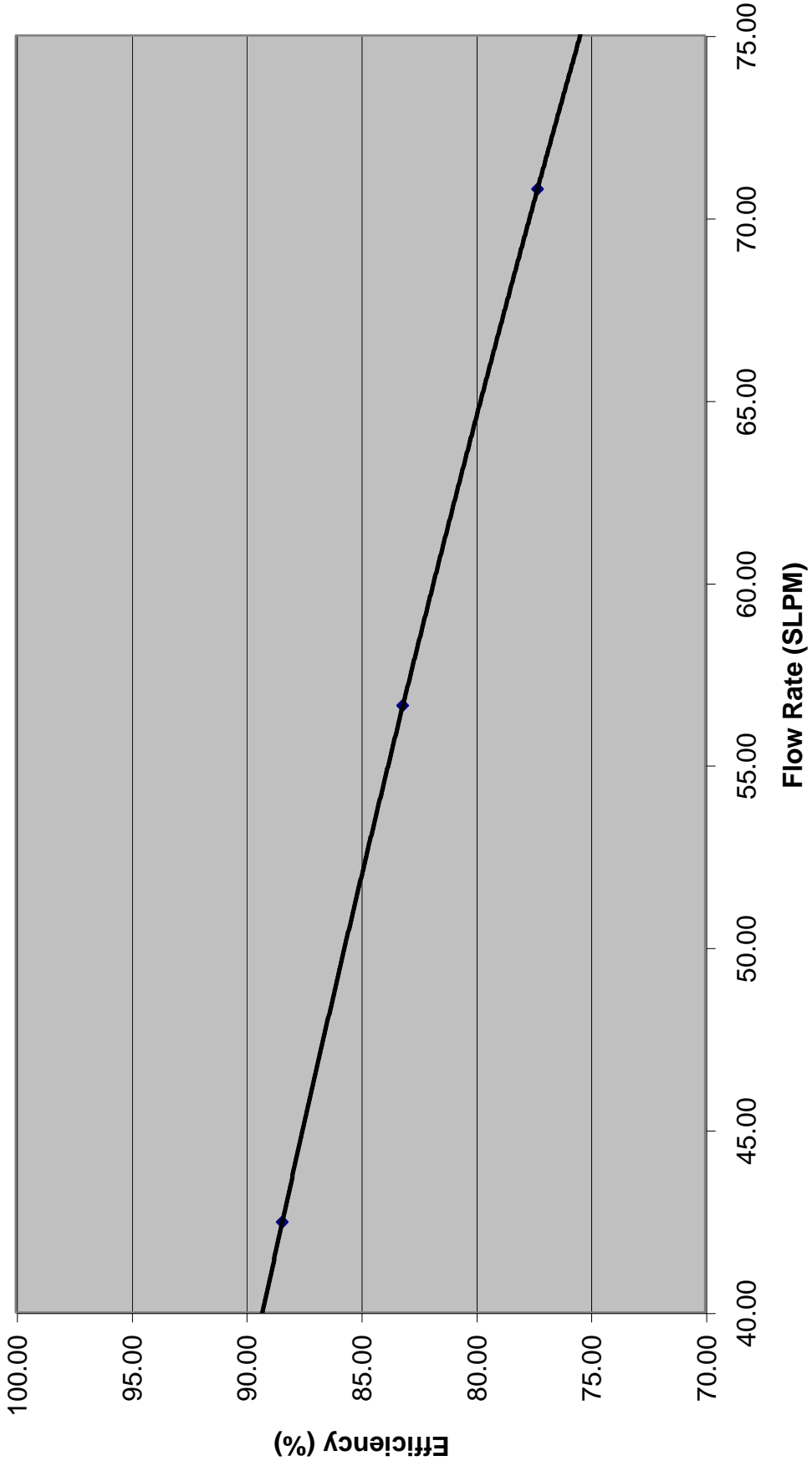

Graph 16

VI. DATA ANALYSIS AND ASSESSMENT

A. CH₃I Retention Efficiency vs. Flow Rate

The CH₃I retention efficiency decreased as the flow rate increased for all sampling scenarios. The relationship between efficiency and flow rate was found to be represented by a quadratic equation for all three of the sampling scenarios. Equations representing the CH₃I retention efficiency for various adsorbents for specific sampling scenarios are provided in the body of this paper along with graphical representations of the curves representing these equations.

B Retention Efficiency as a Function of Particle Size

Smaller particle sizes are represented by larger U.S. Sieve values. For example, a 10×16 mesh adsorbent has larger particles than a 30×50 mesh adsorbent. Refer to Appendix I for the particle size selector table that illustrates U.S. Sieve mesh sizes to particle diameters.

Assessments of the data between the different mesh sizes illustrates that CH₃I retention efficiency increases with decreasing particle size (larger mesh size) of both the charcoal and silver zeolite adsorbent.

This is to be expected since smaller particle size material will present to a gas stream a greater amount of surface area per weight of material. Since adsorption capability is a function of surface area, it is not surprising that the general theory is supported by the data contained in this paper.

C. Retention Efficiency as a Function of Sample Duration

In general, the radioiodine adsorption capacity of a radioiodine cartridge utilized in the commercial nuclear power industry decreases with increasing sample duration.

Very importantly, the methyl iodide retention efficiency as a function of sample duration is heavily influenced by the particle size of the adsorbent.

There tends to be less retention efficiency losses as the average particle size of the adsorbent decreases. For example, TEDA-2 adsorbent (30×50 mesh) retention efficiencies will show considerably less influence for longer sample durations such as the 168 hour long term sampling scenario than the larger particle size TEDA-1 adsorbent (10×16 mesh), provided all other factors remain equal.

D. Pressure Drop Considerations

The pressure drop across a cartridge decreases as the particle size increases.

The pressure drop relationship for the F&J TEDA impregnated cartridge follows the following sequence within specific filter geometry:

TEDA-2 > **TEDA-3** > **TEDA-4** > **TEDA-1**
(30×50) > **(20×40)** > **(12×20)** > **(10×16)**

The same pressure drop relationship holds true for the silver zeolite cartridges within specific filter geometry

$$\text{AGZ58} > \text{AGZ35} > \text{AGZ164}$$

(50×80) (30×50) (16×40)

Larger particle size adsorbents should be selected for applications utilizing battery powered air samplers or lower capacity vacuum blowers and pumps.

In general, one should use finer particle adsorbents (larger mesh sizes) for environmental monitoring applications where lower pollutant concentrations are encountered.

Refer to the graphs in Appendix B illustrating the pressure drop vs. flow rate relationship for various charcoal and zeolite adsorbent particle sizes for the nominal 2 ¼”D × 1”H filter cartridge geometry applicable to F&J’s “C” series, “B” series and “M” series radioiodine collection cartridges.

E. General Conclusion Regarding Retention Efficiencies

The radiation protection specialist involved in the quantitative determination of airborne radioactive iodine species for compliance monitoring should select a radioiodine cartridge, which presents an acceptable pressure drop for the air sampling equipment being utilized in conjunction with any filter paper.

It appears that the optimum mesh size can be obtained by trial and error depending upon the combination of pressure drop and the relative efficiency levels a user is willing to accept for his particular sampling application.

















It is not as important to have the highest efficiency radioiodine collection cartridge possible as it is for the user to have good empirically derived CH₃I efficiency performance data representative of the user’s cartridge and specific field application practices. There is no substitute for good reliable test data and confidence in the quality of the supplier’s radioiodine cartridge manufacturing program when health, safety and compliance monitoring liabilities are present.

APPENDIX A

ACTIVATED CARBON PARTICULATE SELECTOR CHART

Activated Carbon Particulate Selector

To determine approximate mesh size of an activated carbon sample, compare representative particles of the largest and smallest size to the printed solid circles. Mesh size is given in two numbers, e.g., "6x10." The first number is a mesh slightly larger than the largest representative particle, and the second is a mesh slightly smaller than the smallest particle. Normal manufacturing tolerances allow for a few non- representative particles in each sample.

STANDARD MESH		OPENING		PARTICLE
Tyler	U.S.	mm.	inches	
4	4	4.70	0.185	
6	6	3.33	.131	
8	8	2.36	.094	
10	12	1.65	.065	
12	14	1.40	.056	
14	16	1.17	.047	
16	18	0.991	.039	
20	20	.833	.033	
24	25	.701	.028	
28	30	.589	.023	
32	35	.495	.020	
35	40	.417	.016	
42	45	.351	.014	
48	50	.295	.012	
60	60	.246	.0097	
80	80	.175	.0069	
100	100	.147	.0058	
150	140	.104	.0041	
200	200	.074	.0029	
250	230	.061	.0024	
325	325	.043	.0017	
400	400	.038	.0015	

APPENDIX B

Pressure Drop vs. Flow Rate for TEDA Impregnated Charcoals and Silver Zeolite Media

Pressure Drop Vs. Flow Rate
AGZ164, 16x40 Mesh, Intermediate, 6/15/2004
C;M;B Geometry

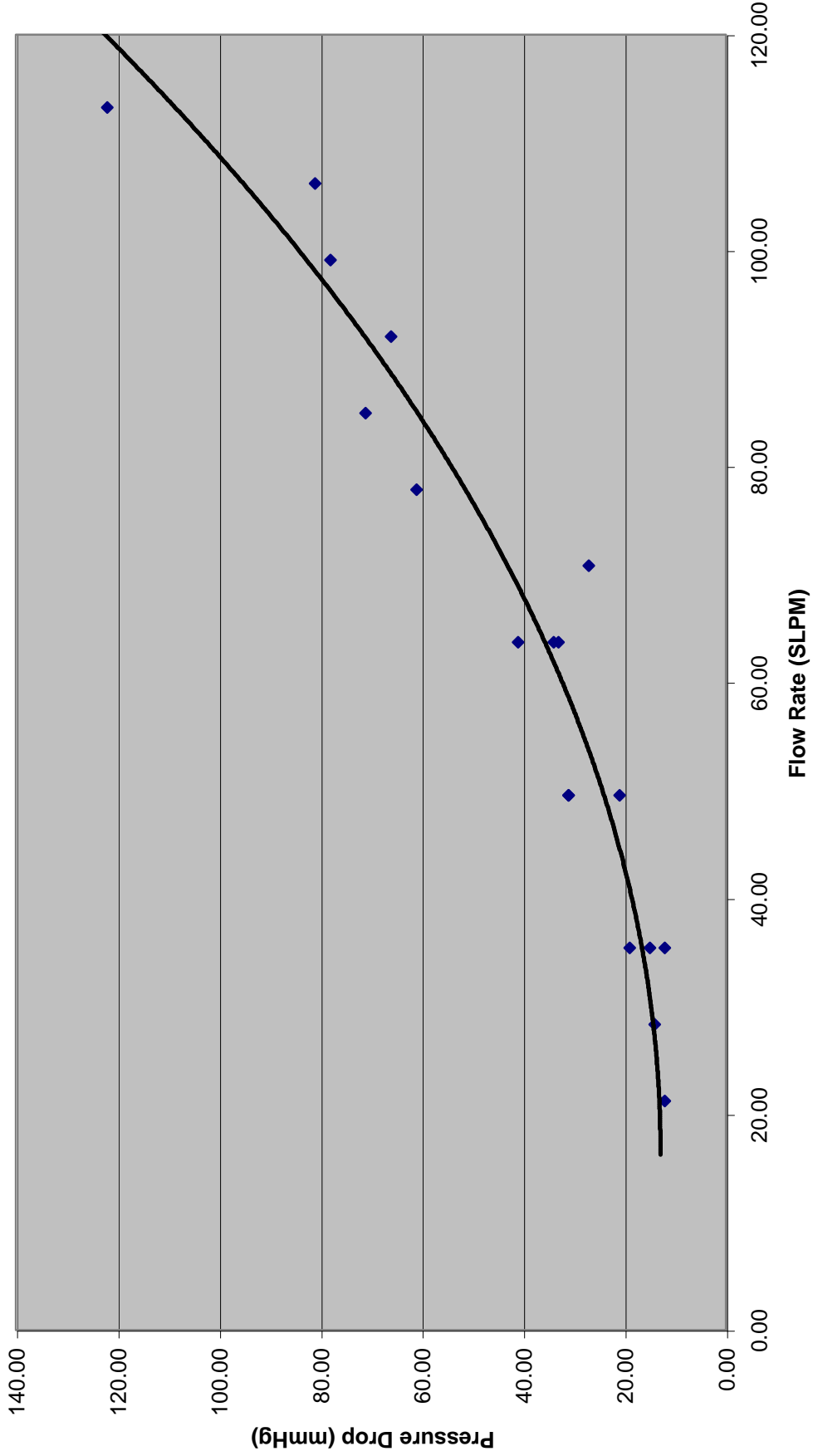

Pressure Drop vs. Flow Rate
AGZ, 16x40 Mesh, Intermediate, 6/15/2004
C;M;B Geometry

Equation: $y = 0.0102x^2 - 0.3378x + 15.684$
Standard Deviation: 7.8785

Point	Flow Rate SLPM	Pressure Drop mmHg	Calculated Pressure Drop	Difference
1	21.24	12.00	13.11	-1.11
2	28.32	14.00	14.30	-0.30
3	35.40	15.00	16.51	-1.51
4	35.40	12.00	16.51	-4.51
5	35.40	19.00	16.51	2.49
6	49.55	31.00	23.99	7.01
7	49.55	21.00	23.99	-2.99
8	49.55	31.00	23.99	7.01
9	63.71	33.00	35.57	-2.57
10	63.71	34.00	35.57	-1.57
11	63.71	41.00	35.57	5.43
12	70.79	27.00	42.89	-15.89
13	77.87	61.00	51.23	9.77
14	84.95	71.00	60.60	10.40
15	92.03	66.00	70.99	-4.99
16	99.11	78.00	82.40	-4.40
17	106.19	81.00	94.83	-13.83
18	113.27	122.00	108.28	13.72

Pressure Drop Vs. Flow Rate
AGZ, 30x50 Mesh, Intermediate, 8/10/2004
C;M;B Geometry

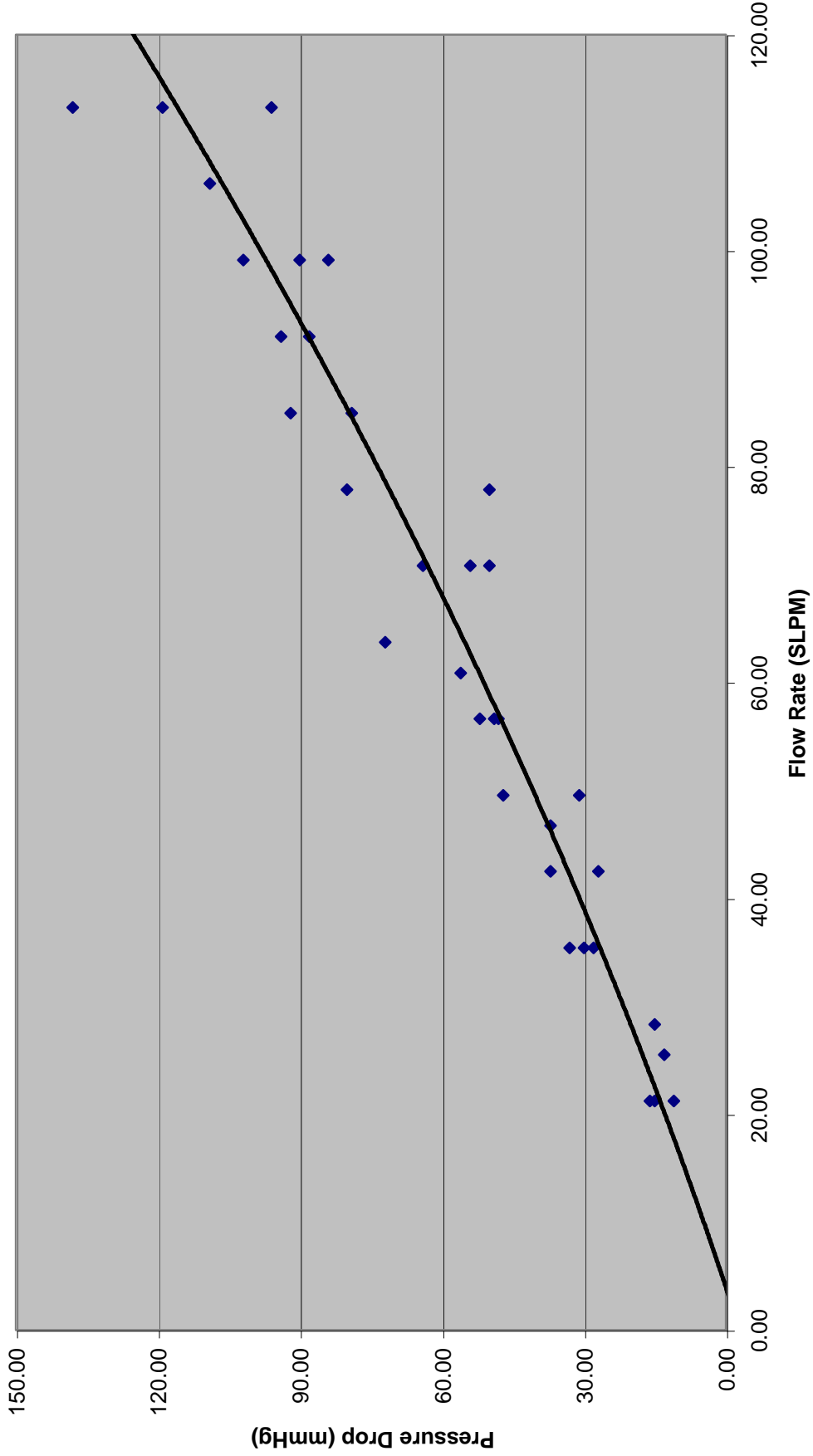

Pressure Drop vs. Flow Rate
AGZ, 30x50 Mesh, Intermediate, 8/10/2004
C;M;B Geometry

Equation: $y = 0.0028x^2 + 0.7365x - 2.9578$
Standard Deviation: 9.10746

Point	Flow Rate SLPM	Pressure Drop mmHg	Calculated Pressure Drop	Difference
1	21.24	11.00	13.95	-2.95
2	21.24	16.00	13.95	2.05
3	21.24	15.00	13.95	1.05
4	25.49	13.00	17.63	-4.63
5	28.32	15.00	20.14	-5.14
6	35.40	33.00	26.62	6.38
7	35.40	28.00	26.62	1.38
8	35.40	30.00	26.62	3.38
9	42.48	37.00	33.38	3.62
10	42.48	27.00	33.38	-6.38
11	46.72	37.00	37.57	-0.57
12	49.55	31.00	40.41	-9.41
13	49.55	47.00	40.41	6.59
14	56.63	52.00	47.73	4.27
15	56.63	49.00	47.73	1.27
16	56.63	48.00	47.73	0.27
17	60.88	56.00	52.26	3.74
18	63.71	72.00	55.33	16.67
19	70.79	64.00	63.21	0.79
20	70.79	54.00	63.21	-9.21
21	70.79	50.00	63.21	-13.21
22	77.87	50.00	71.37	-21.37
23	77.87	80.00	71.37	8.63
24	84.95	79.00	79.81	-0.81
25	84.95	92.00	79.81	12.19
26	92.03	94.00	88.54	5.46
27	92.03	88.00	88.54	-0.54
28	99.11	102.00	97.54	4.46
29	99.11	90.00	97.54	-7.54
30	99.11	84.00	97.54	-13.54
31	106.19	109.00	106.82	2.18
32	113.27	96.00	116.39	-20.39
33	113.27	138.00	116.39	21.61
34	113.27	119.00	116.39	2.61

Pressure Drop Vs. Flow Rate
AGZ, 50x80 Mesh, Intermediate, 3/14/2001
C;M;B Geometry

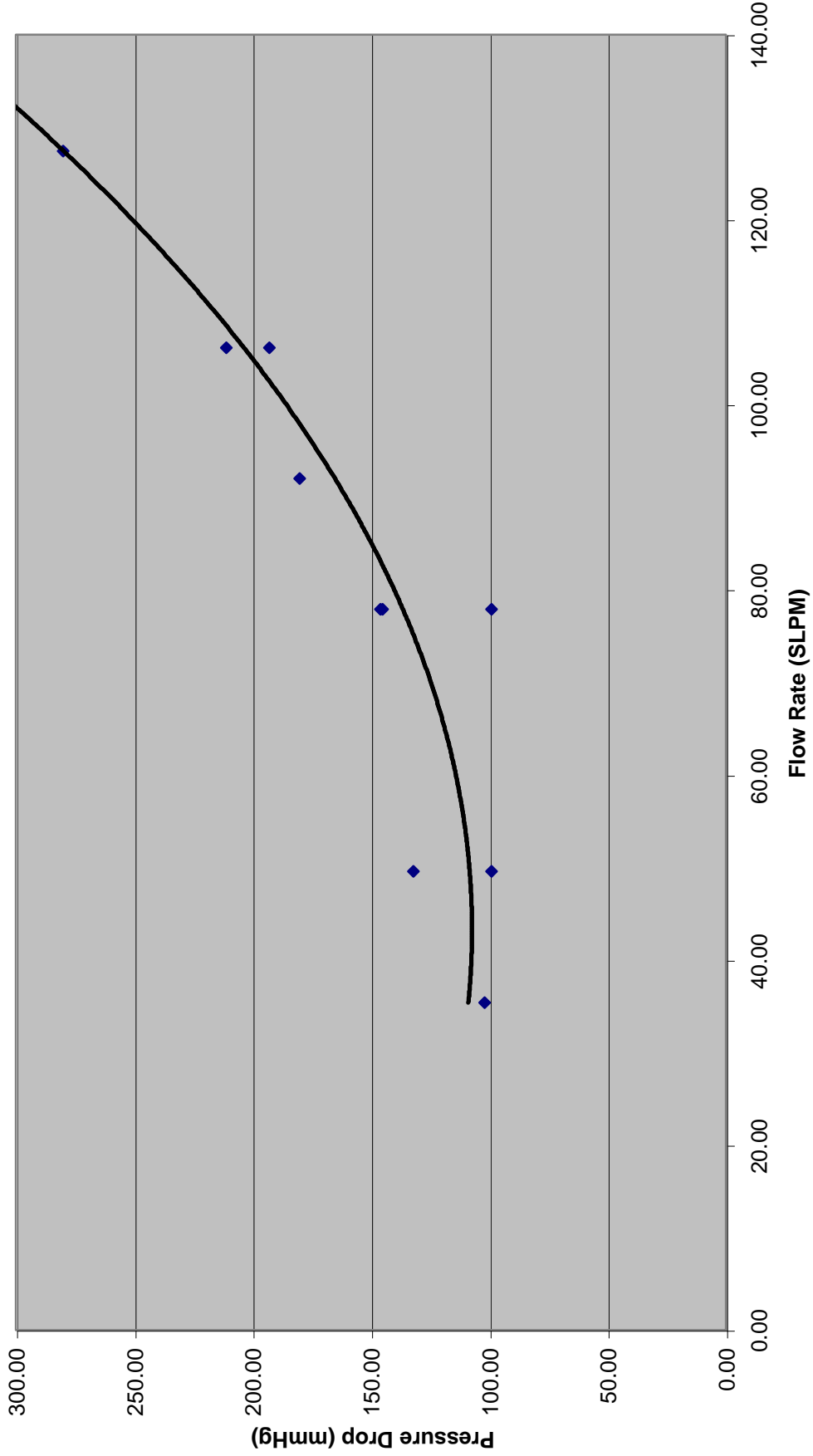

Pressure Drop vs. Flow Rate
AGZ, 50x80 Mesh, Intermediate, 3/14/2001
C;M;B Geometry

Equation: $y = 0.0244x^2 - 2.1114x + 153$
Standard Deviation: 17.1585

Point	Flow Rate SLPM	Pressure Drop mmHg	Calculated Pressure Drop	Difference
1	35.40	102.00	108.84	-6.84
2	49.55	132.00	108.29	23.71
3	49.55	99.00	108.29	-9.29
4	77.87	145.00	136.54	8.46
5	77.87	146.00	136.54	9.46
6	77.87	99.00	136.54	-37.54
7	92.03	180.00	165.34	14.66
8	106.19	211.00	203.93	7.07
9	106.19	193.00	203.93	-10.93
10	127.43	280.00	280.14	-0.14

Pressure Drop Vs. Flow Rate
TE1, 8x16 Mesh, Intermediate, 10/10/2002
C;M;B Geometry

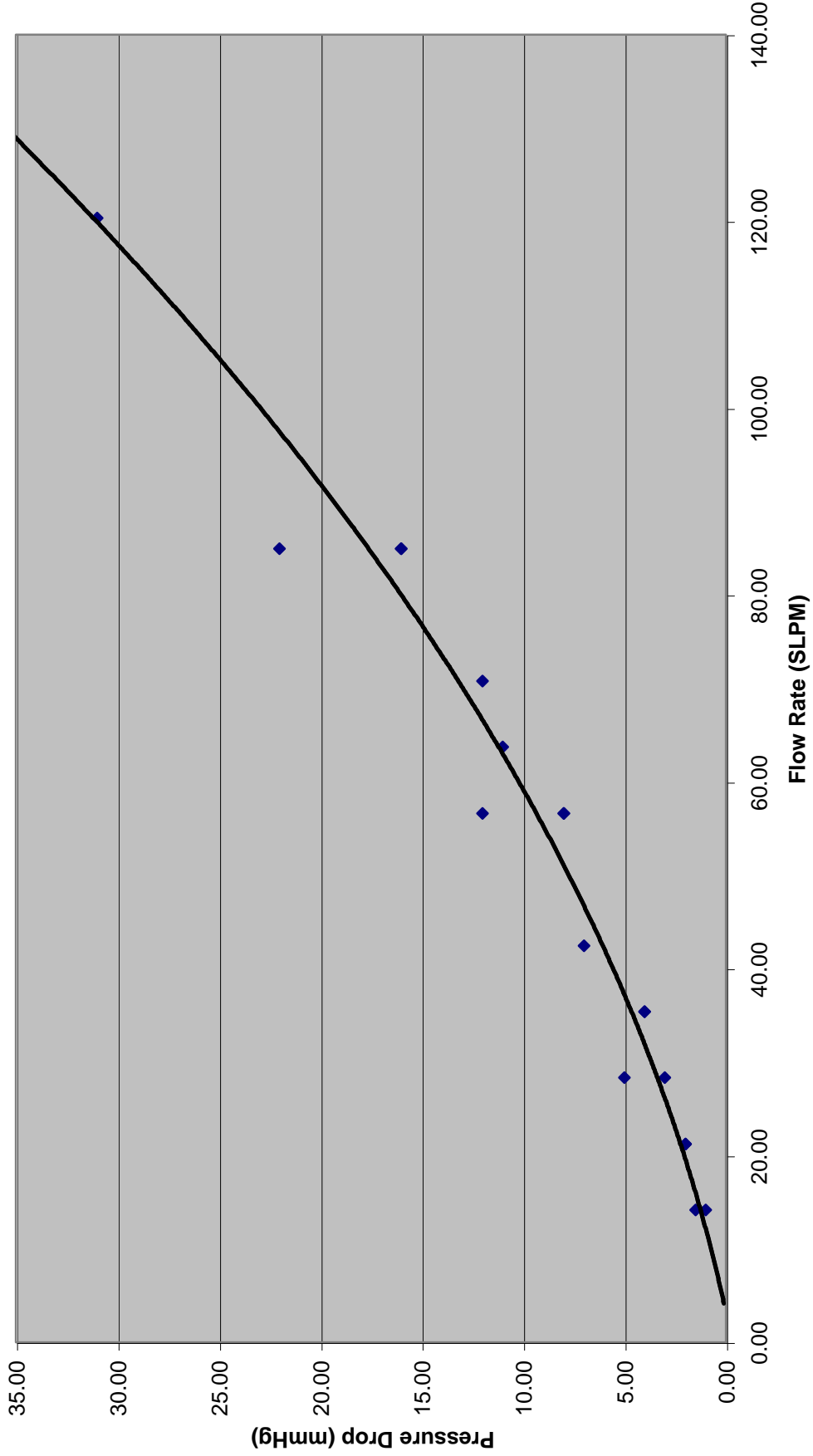

Pressure Drop vs. Flow Rate
TE1C, 8x16 Mesh, Intermediate, 3/14/2001
C;M;B Geometry

Equation: $y = 0.0014x^2 + 0.0891x - 0.2986$
Standard Deviation: 1.564

Point	Flow Rate SLPM	Pressure Drop mmHg	Calculated Pressure Drop	Difference
1	14.16	1.50	1.24	0.26
2	14.16	1.00	1.24	-0.24
3	21.24	2.00	2.23	-0.23
4	21.24	2.00	2.23	-0.23
5	28.32	3.00	3.35	-0.35
6	28.32	5.00	3.35	1.65
7	35.40	4.00	4.61	-0.61
8	35.40	4.00	4.61	-0.61
9	42.48	7.00	6.01	0.99
10	56.63	8.00	9.24	-1.24
11	56.63	8.00	9.24	-1.24
12	56.63	12.00	9.24	2.76
13	63.71	11.00	11.06	-0.06
14	70.79	12.00	13.03	-1.03
15	84.95	16.00	17.37	-1.37
16	84.95	16.00	17.37	-1.37
17	84.95	22.00	17.37	4.63
18	120.35	31.00	30.70	0.30

Pressure Drop Vs. Flow Rate
TE2, 30x50 Mesh, Intermediate, 12/17/2003
C;M;B Geometry

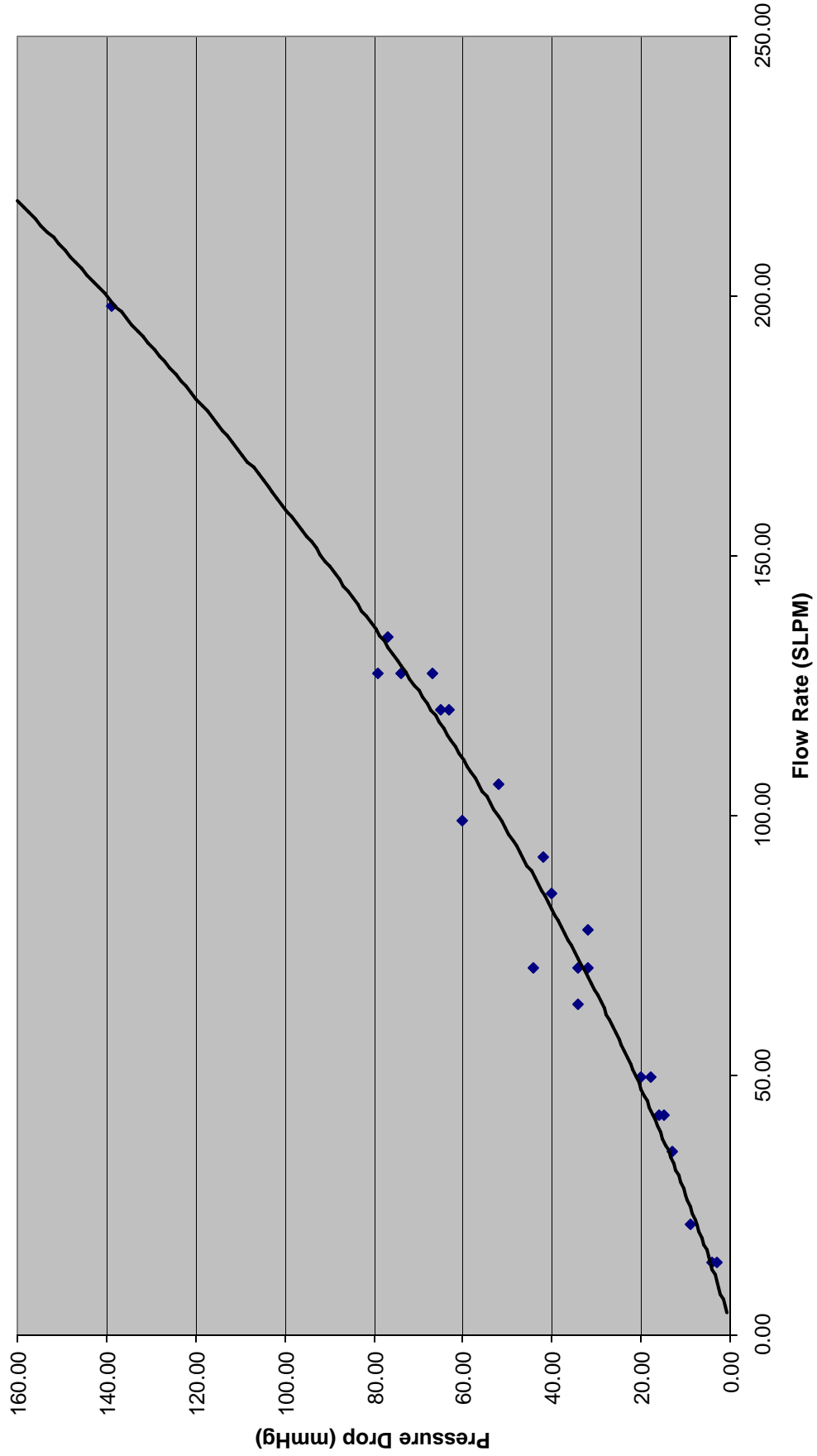

Pressure Drop vs. Flow Rate
TE2C, 30x50 Mesh, Intermediate, 12/17/2003
C;M;B Geometry

Equation: $y = 0.0017x^2 + 0.356x - 1.1874$
Standard Deviation: 4.275

Point	Flow Rate SLPM	Pressure Drop mmHg	Calculated Pressure Drop	Difference
1	14.16	4.00	4.19	-0.19
2	14.16	2.80	4.19	-1.39
3	21.24	9.00	7.14	1.86
4	35.40	13.00	13.54	-0.54
5	42.48	16.00	17.00	-1.00
6	42.48	15.00	17.00	-2.00
7	49.55	20.00	20.63	-0.63
8	49.55	18.00	20.63	-2.63
9	63.71	34.00	28.40	5.60
10	70.79	32.00	32.53	-0.53
11	70.79	44.00	32.53	11.47
12	70.79	34.00	32.53	1.47
13	77.87	32.00	36.84	-4.84
14	84.95	40.00	41.32	-1.32
15	92.03	42.00	45.97	-3.97
16	99.11	60.00	50.79	9.21
17	106.19	52.00	55.78	-3.78
18	120.35	63.00	66.28	-3.28
19	120.35	65.00	66.28	-1.28
20	127.43	67.00	71.78	-4.78
21	127.43	79.00	71.78	7.22
22	127.43	74.00	71.78	2.22
23	134.51	77.00	77.45	-0.45
24	198.22	139.00	136.17	2.83

Pressure Drop Vs. Flow Rate
TE3, 20x40 Mesh, Intermediate, 3/14/2001
C;M;B Geometry

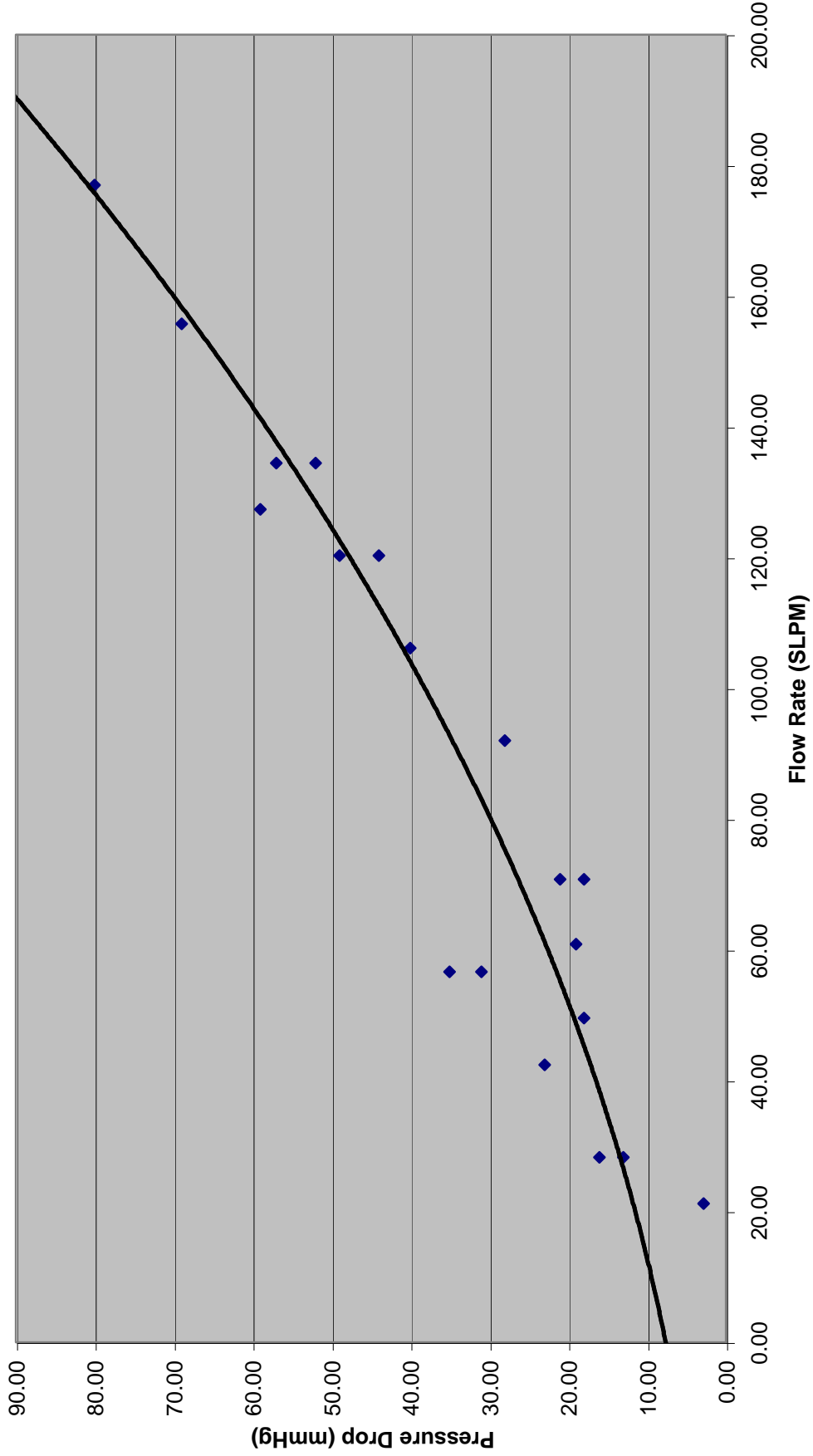

Pressure Drop vs. Flow Rate
TE3, 20x40 Mesh, Intermediate, 3/14/2001
C;M;B Geometry

Equation: $y = 0.0014x^2 + 0.1641x + 7.6395$

Standard Deviation: 5.9875

Point	Flow Rate SLPM	Pressure Drop mmHg	Calculated Pressure Drop	Difference
1	21.24	2.80	11.76	-8.96
2	28.32	13.00	13.41	-0.41
3	28.32	16.00	13.41	2.59
4	42.48	23.00	17.14	5.86
5	49.55	18.00	19.21	-1.21
6	56.63	31.00	21.42	9.58
7	56.63	35.00	21.42	13.58
8	60.88	19.00	22.82	-3.82
9	70.79	18.00	26.27	-8.27
10	70.79	21.00	26.27	-5.27
11	92.03	28.00	34.60	-6.60
12	106.19	40.00	40.85	-0.85
13	120.35	44.00	47.67	-3.67
14	120.35	49.00	47.67	1.33
15	127.43	59.00	51.28	7.72
16	134.51	57.00	55.04	1.96
17	134.51	52.00	55.04	-3.04
18	155.74	69.00	67.15	1.85
19	176.98	80.00	80.53	-0.53

Pressure Drop Vs. Flow Rate
TE4, 12x20 Mesh, Intermediate, 12/17/2003
C;M;B Geometry

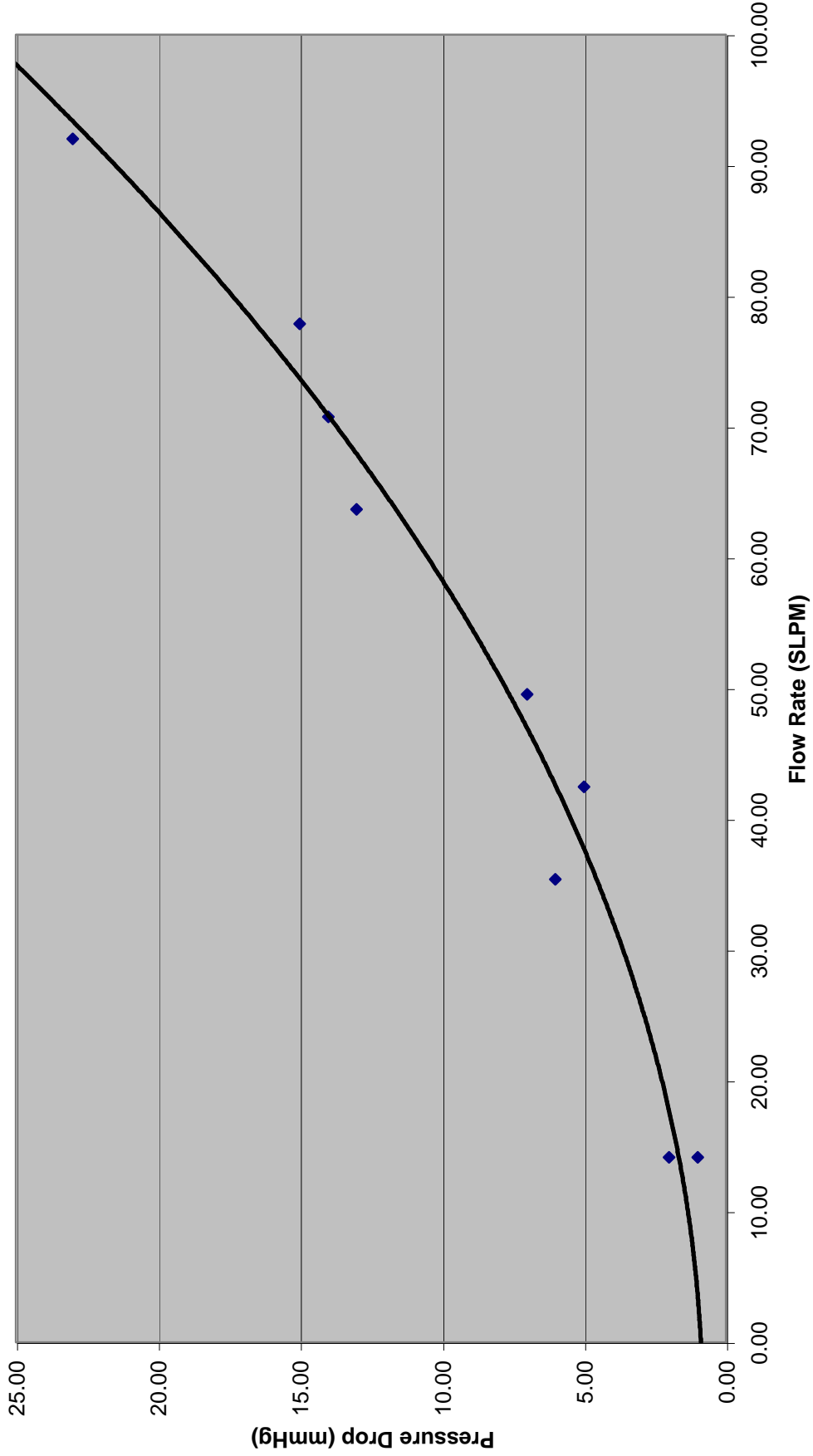

Pressure Drop vs. Flow Rate
TE4, 12x20 Mesh, Intermediate, 12/17/2003
C;M;B Geometry

Equation: $y = 0.0023x^2 + 0.0223x + 0.8826$
Standard Deviation: 1.03988

Point	Flow Rate SLPM	Pressure Drop mmHg	Calculated Pressure Drop	Difference
1	14.16	1.00	1.66	-0.66
2	14.16	2.00	1.66	0.34
3	35.40	6.00	4.55	1.45
4	42.48	5.00	5.98	-0.98
5	49.55	7.00	7.64	-0.64
6	63.71	13.00	11.64	1.36
7	70.79	14.00	13.99	0.01
8	77.87	15.00	16.57	-1.57
9	92.03	23.00	22.41	0.59

APPENDIX C

**CSM SERIES
PLASTIC CASING**

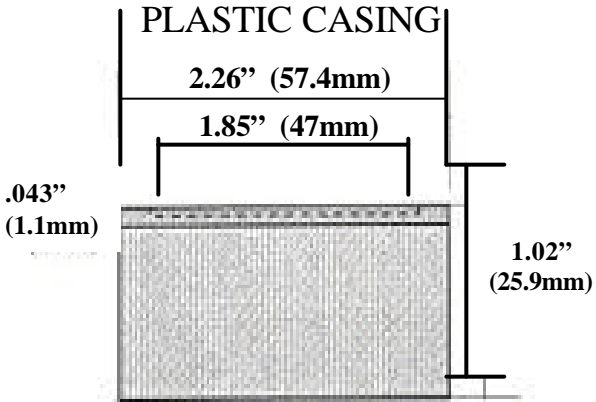

**CSM SERIES
ISOMETRIC VIEW**

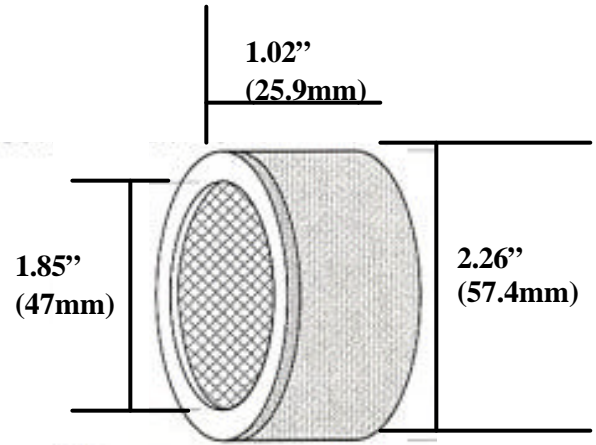

**MODEL "B" SERIES
PLASTIC CASING**

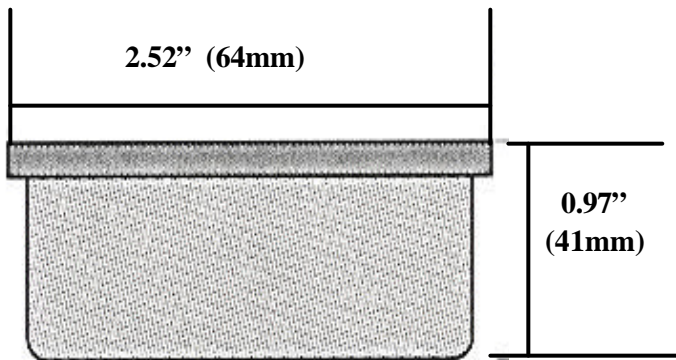

.043" This indented surface is designed for placement of 47mm Filter Paper on the inlet surface of the charcoal cartridge

**MODEL "C" SERIES
PLASTIC CASING**

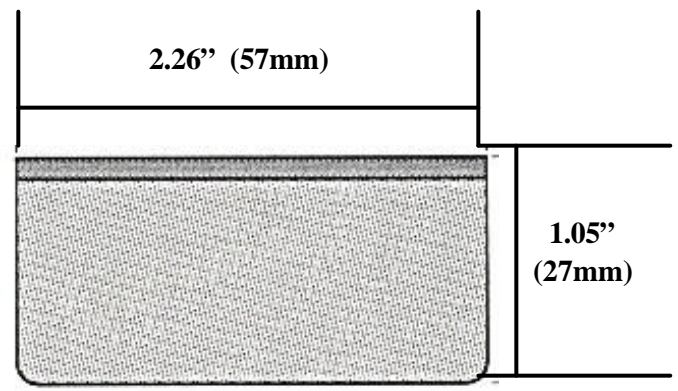

**MODEL "M" SERIES
METAL CASING**

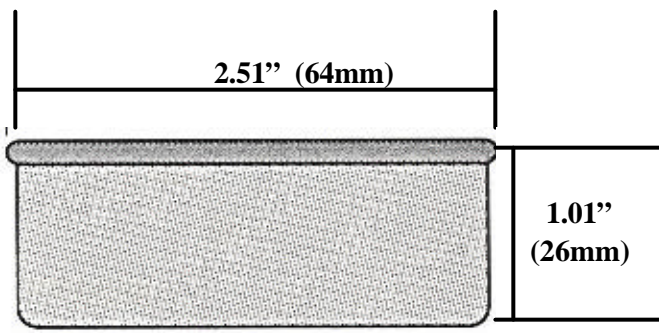

**CS SERIES
PLASTIC CASING**

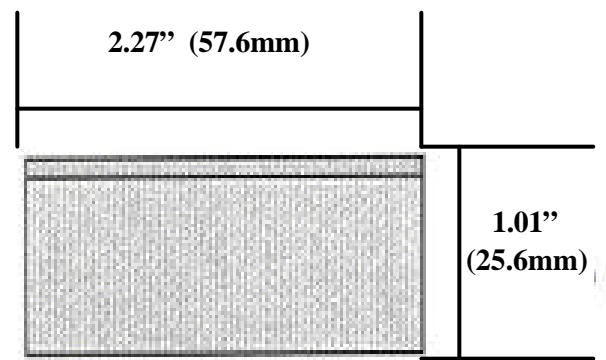

NOTE:
These sketches are not to scale.

APPENDIX D

Equations for Methyl Iodide Collection Efficiency vs. Flowrate for TEDA Impregnated Charcoal Cartridges and Silver Zeolite Cartridges Applicable to Series C, CS, CSM, B and M

Short-Term Sampling Scenario

Adsorbent Type	X = CFM Equations	X = LPM Equations
AGZ58	$y = -0.1674x^2 - 0.0417x + 100.17$	$y = -0.0002x^2 - 0.0015x + 100.17$
TEDA-1	$y = 0.3845x^2 - 7.1557x + 106.04$	$y = 0.0005x^2 - 0.2529x + 106.04$
TEDA-2	$y = -0.4758x^2 + 0.8722x + 99.689$	$y = -0.0006x^2 + 0.0308 + 99.689$
TEDA-3	$y = -0.1253x^2 - 3.4068x + 101.52$	$y = -0.0002x^2 - 0.1188x + 101.52$
TEDA-4	$y = -2.174x^2 - 3.019x + 100.14$	$y = -0.0027x^2 - 0.1065x + 100.14$

Intermediate-Term Sampling Scenario

Adsorbent Type	X = CFM Equations	X = LPM Equations
AGZ164	$y = 0.5536x^2 - 9.0577x + 107.53$	$y = 0.0007x^2 - 0.3199x + 107.53$
AGZ35	$y = 0.0356x^2 - 3.8411x + 103.36$	$y = 0.00004x^2 - 0.1357x + 103.36$
AGZ58	$y = -0.0562x^2 - 0.5124x + 100.36$	$y = -0.00007x^2 - 0.018x + 100.36$
TEDA-1	$y = 0.8783x^2 - 15.571x + 106.65$	$y = 0.0011x^2 - 0.5502x + 106.65$
TEDA-2	$y = -0.2647x^2 - 0.3636x + 100.49$	$y = -0.0003x^2 - 0.0128x + 100.49$
TEDA-3	$y = 0.0467x^2 - 4.3026x + 104.13$	$y = 0.00006x^2 - 0.1519x + 104.13$
TEDA-4	$y = 3.2638x^2 - 25.612x + 110.48$	$y = 0.0041x^2 - 0.9045x + 110.48$

Long-Term Sampling Scenario

Adsorbent Type	X = CFM Equations	X = LPM Equations
TEDA-1	$y = 2.295x^2 - 20.365x + 103.33$	$y = 0.0029x^2 - 0.7192x + 103.33$
TEDA-2	$y = -0.1414x^2 - 0.3481x + 99.923$	$y = -0.0002x^2 - 0.0123x + 99.923$
TEDA-3	$y = -0.4928x^2 - 1.3921x + 100.91$	$y = -0.0006x^2 - 0.0492x + 100.91$
TEDA-4	$y = -1.22x^2 - 6.23x + 100.49$	$y = -0.0015x^2 - 0.2211x + 100.49$